

Fast Time Response, For Scintillation Counting and High Energy Physics
R6427: Borosilicate Glass, R7056: UV Glass

GENERAL

Parameter		Description / Value	Unit
Spectral Response	R6427	300 to 650	nm
	R7056	185 to 650	nm
Wavelength of Maximum Response		420	nm
Photocathode	Material	bialkali	—
	Minimum Effective Area	φ25	mm
Window Material	R6427	Borosilicate glass	—
	R7056	UV glass	—
Dynode	Structure	Linear focused	—
	Number of Stages	10	—
Operating Ambient Temperature		-30 to +50	°C
Storage Temperature		-80 to +50	°C
Base		14-pin glass base	—
Suitable Socket		E678-14C (supplied)	—

MAXIMUM RATINGS (Absolute Maximum Values)

Parameter		Value	Unit
Supply Voltage	Between Anode and Cathode	2000	V
	Between Anode and Last Dynode	350	V
Average Anode Current		0.1	mA

CHARACTERISTICS (at 25 °C)

Parameter		Min.	Typ.	Max.	Unit
Cathode Sensitivity	Luminous (2856 K)	70	100	—	μA/lm
	Radiant at 420 nm	—	88	—	mA/W
	Blue Sensitivity Index (CS 5-58)	—	11.0	—	—
Anode Sensitivity	Luminous (2856 K)	—	500	—	A/lm
	Radiant at 420 nm	—	4.4 × 10 ⁵	—	A/W
Gain		—	5.0 × 10 ⁶	—	—
Anode Dark Current (after 30 min. storage in darkness)		—	10	200	nA
Time Response	Anode Pulse Rise Time	—	1.7	—	ns
	Electron Transit Time	—	16	—	ns
	Transit Time Spread (FWHM)	—	500	—	ps
Pulse Linearity (at 2 % deviation)		—	10 (100)	—	mA

NOTE: Anode characteristics are measured with the voltage distribution ratio A shown below.
(): Pulse linearity is measured with the voltage distribution ratio B shown below.

VOLTAGE DISTRIBUTION RATIO AND SUPPLY VOLTAGE

Electrodes	K	Dy1	Dy2	Dy3	Dy4	Dy5	Dy6	Dy7	Dy8	Dy9	Dy10	P
Ratio A	4	1	1.5	1	1	1	1	1	1	1	1	1
Ratio B (Tapered)	4	1	1.5	1	1	1	1.2	1.5	2	3.3	3	
Capacitors (μF)							0.01	0.02	0.02	0.04	0.06	

Supply Voltage: 1500 Vdc, K: Cathode, DY: Dynode, P: Anode

PHOTOMULTIPLIER TUBES R6427, R7056

Figure 1: Typical Spectral Response

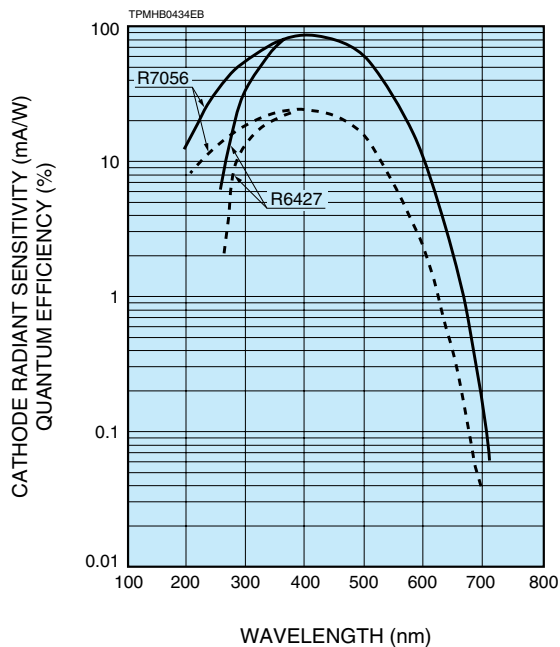

Figure 2: Typical Gain

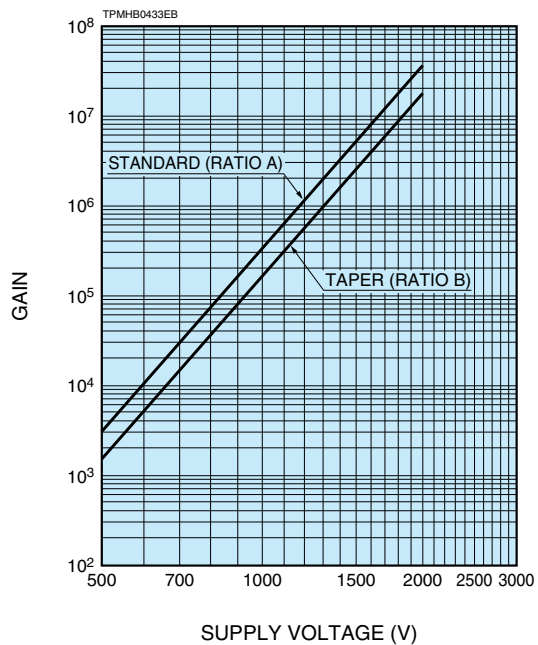

Figure 3: Typical Pulse Height Distribution (P.H.D.)

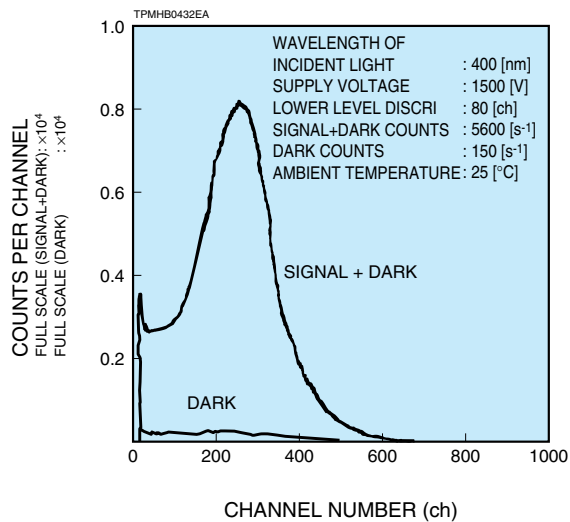

Figure 4: Time Response

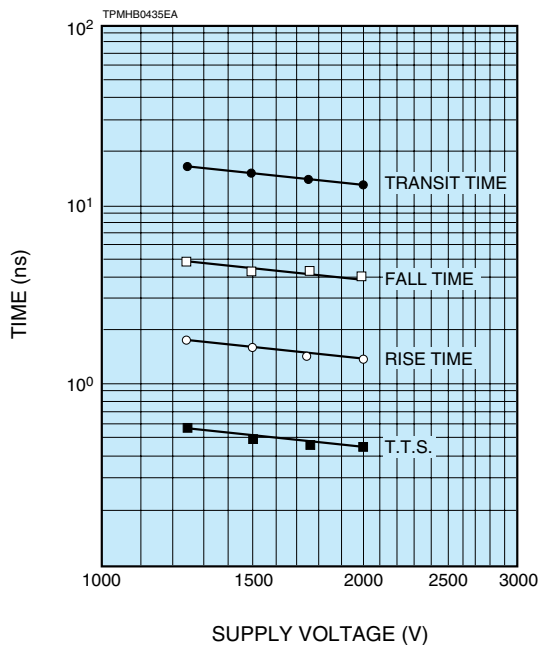

Figure 5: Anode Output Waveform

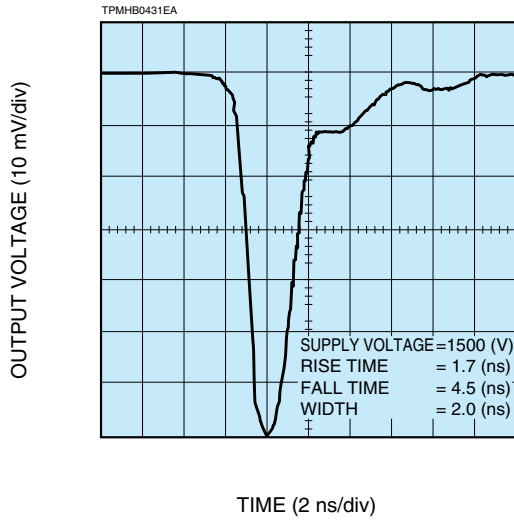

Figure 6: Transit Time Spread (T.T.S.)

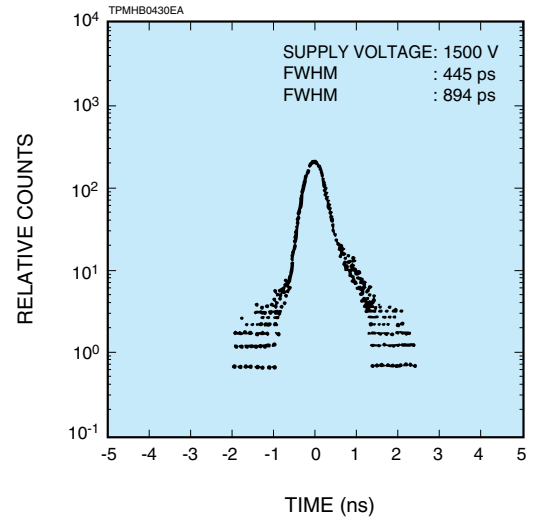
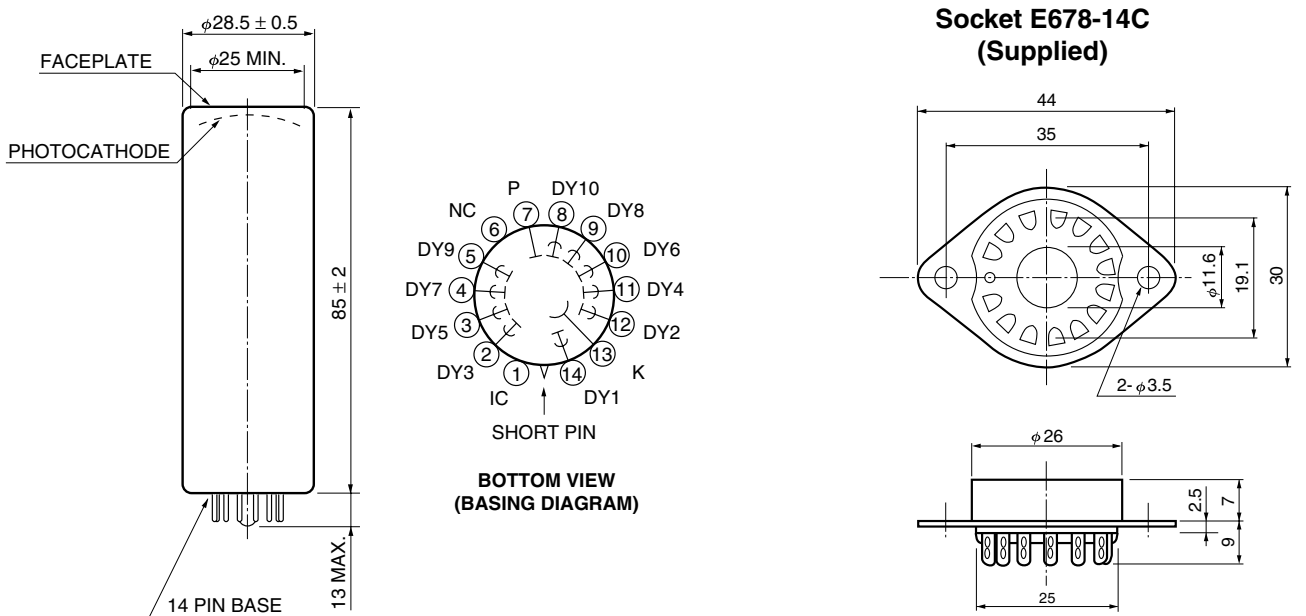

Figure 7: Dimensional Outline and Basing Diagram (Unit: mm)



PHOTOMULTIPLIER TUBES R6427, R7056

[ACCESSORIES]

●D-type Socket Assembly E2624-14 (for RATIO A)

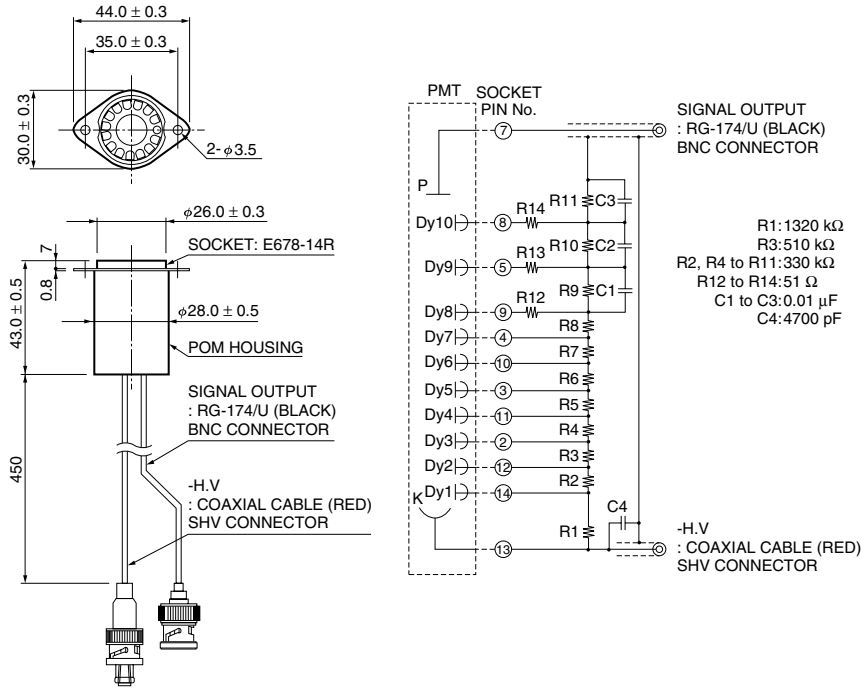

TACCA0082EC

●D-type Socket Assembly E2624-04 (for RATIO B)

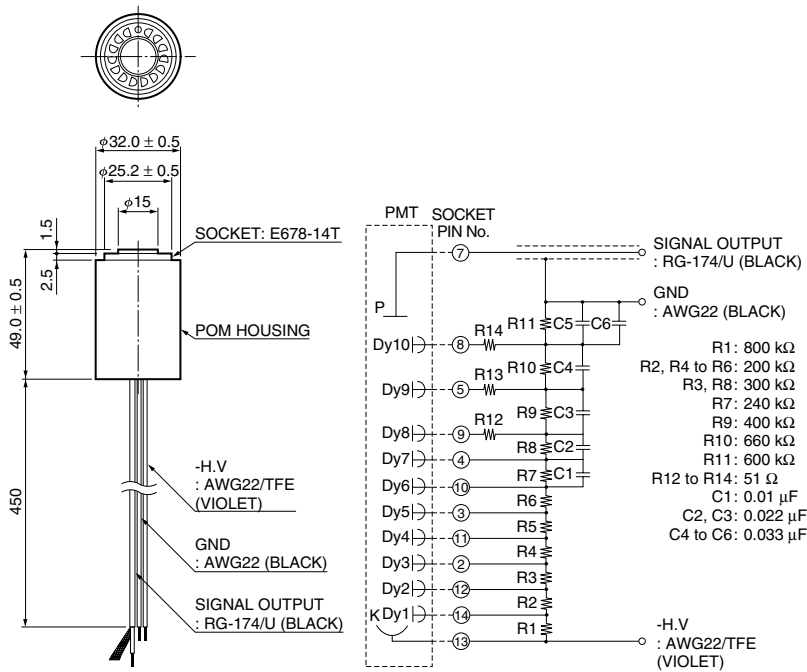

TACCA0084EC

HAMAMATSU PHOTONICS K.K. www.hamamatsu.com

HAMAMATSU PHOTONICS K.K., Electron Tube Division

314-5, Shimokanzo, Iwata City, Shizuoka Pref., 438-0193, Japan, Telephone: (81)539/62-5248, Fax: (81)539/62-2205

U.S.A.: Hamamatsu Corporation: 360 Foothill Road, P. O. Box 6910, Bridgewater, N.J. 08807-0910, U.S.A., Telephone: (1)908-231-0960, Fax: (1)908-231-1218 E-mail: usa@hamamatsu.com

Germany: Hamamatsu Photonics Deutschland GmbH: Arzbergerstr. 10, D-82211 Herrsching am Ammersee, Germany, Telephone: (49)8152-375-0, Fax: (49)8152-2658 E-mail: info@hamamatsu.de

France: Hamamatsu Photonics France S.A.R.L.: 19, Rue du Saule Trapu, Parc du Moulin de Massy, 91882 Massy Cedex, France, Telephone: (33)1 69 53 71 00, Fax: (33)1 69 53 71 10 E-mail: infos@hamamatsu.fr

United Kingdom: Hamamatsu Photonics UK Limited: 2 Howard Court, 10 Tewin Road Welwyn Garden City Hertfordshire AL7 1BW, United Kingdom, Telephone: 44-(0)1707-294888, Fax: 44(0)1707-325777 E-mail: info@hamamatsu.co.uk

North Europe: Hamamatsu Photonics Norden AB: Smidesvägen 12, SE-171-41 SOLNA, Sweden, Telephone: (46)8-509-031-00, Fax: (46)8-509-031-01 E-mail: info@hamamatsu.se

Italy: Hamamatsu Photonics Italia: S.R.L.: Strada della Moia, 1/E, 20020 Arese, (Milano), Italy, Telephone: (39)02-935 81 733, Fax: (39)02-935 81 741 E-mail: info@hamamatsu.it

TPMH1187E05
DEC. 2010 IP