

MPPC® (Multi-Pixel Photon Counter)

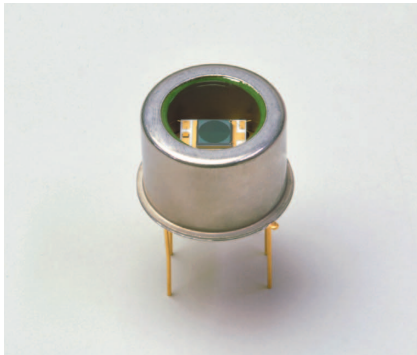

S14422 series

High sensitivity, low noise MPPC for visible and near infrared region

MPPC, also called Si PM (silicon photomultipliers), is a new type of photon counting device that consists of multiple Geiger mode APD (avalanche photodiode) pixels. It is an opto-semiconductor with outstanding photon counting capability and low operating voltage and is immune to the effects of magnetic fields.

The S14422 series is an MPPC for the visible to near infrared region. It provides higher photon detection efficiency than the previous product (S13362 series) in the visible to near infrared region. In addition, the built-in TE-cooler function provides low crosstalk and low afterpulses as well as reduces the dark count to 1/10 that of the non-cooled type (S14420 series).

Features

- Low dark count: 1/10 that of the non-cooled type (-10 °C)
- High photon detection efficiency: 40% ($\lambda=600$ nm, $V_{op}=V_{BR} + 5$, 50 μ m pitch)
- Low crosstalk, low afterpulses
- Low voltage ($V_{BR}=40.5$ V typ.) operation (-10 °C)
- High gain: 10^5 to 10^6
- Operates with simple readout circuit
- MPPC module also available (sold separately)

Applications

- Flow cytometry
- Laser scan microscope
- Fluorescence measurement

Structure

Parameter	S14422-1525DG	S14422-1550DG	S14422-3025DG	S14422-3050DG	Unit
Pixel pitch	25	50	25	50	μ m
Effective photosensitive area	$\phi 1.5$		$\phi 3.0$		mm
Number of pixels	2876	724	11344	2836	-
Fill factor	63	81	63	81	%
Package	Metal (TO-8)				-
Window material	Borosilicate glass				-
Window refractive index	1.52				-
Cooling	Two-stage TE-cooled				-

Absolute maximum ratings

Parameter	Symbol	S14422-1525DG	S14422-1550DG	S14422-3025DG	S14422-3050DG	Unit
Operating temperature*1	Topr	-20 to +60				°C
Storage temperature*1	Tstg	-20 to +85				°C
Chip temperature	Tchip	-25 to ambient temperature				°C
Thermistor power dissipation	Pd_th	0.2				mW
Allowable TE-cooler current	ITE max	1				A
Allowable TE-cooler voltage	VTE max	0.9				V
Soldering conditions*2	Tsol	Peak temperature: 350 °C*3, once, 3 s max.				-

*1: No dew condensation

When there is a temperature difference between a product and the surrounding area in high humidity environment, dew condensation may occur on the product surface. Dew condensation on the product may cause deterioration in characteristics and reliability.

*2: At least 1 mm away from lead roots

*3: Soldering iron tip

Note: Exceeding the absolute maximum ratings even momentarily may cause a drop in product quality. Always be sure to use the product within the absolute maximum ratings.

Electrical and optical characteristics (Typ. Ta=25 °C, Tchip=-10 °C, unless otherwise noted)

Parameter	Symbol	S14422-1525DG	S14422-1550DG	S14422-3025DG	S14422-3050DG	Unit
Spectral response range	λ	350 to 1000				nm
Peak sensitivity wavelength	λ_p	600				nm
Photon detection efficiency*4	PDE	30	40	30	40	%
Dark count	Typ.	35				kcps
	Max.	90				
Terminal capacitance	Ct	90				pF
Gain	M	0.9×10^6	3.6×10^6	0.9×10^6	3.6×10^6	-
Breakdown voltage	VBR	40.5 ± 5				V
Crosstalk probability	-	1.5	5	1.5	5	%
Recommended operating voltage*5	Vop	$V_{BR} + 5$				V
Temperature coefficient at recommended operating voltage	ΔTV_{op}	47				mV/°C
Recommended TE-cooler temperature	TTE_recom	-10				°C
Thermistor resistance*6	Rth	9				k Ω
Thermistor B constant*7	B	3410				K

*4: $\lambda = \lambda_p$, photon detection efficiency does not include crosstalk or afterpulses.

*5: Refer to the data provided with the product.

*6: Thermistor temperature=25 °C

*7: T1=25 °C, T2=50 °C

Note: The above characteristics were measured at the operating voltage that yields the listed gain. (See the data attached to each product.)

Connection example

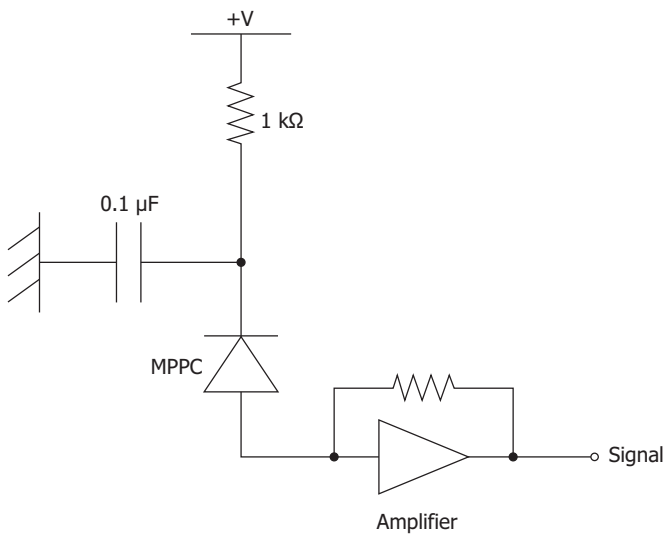

KAPDC0024EB

Photon detection efficiency vs. wavelength (typical example)

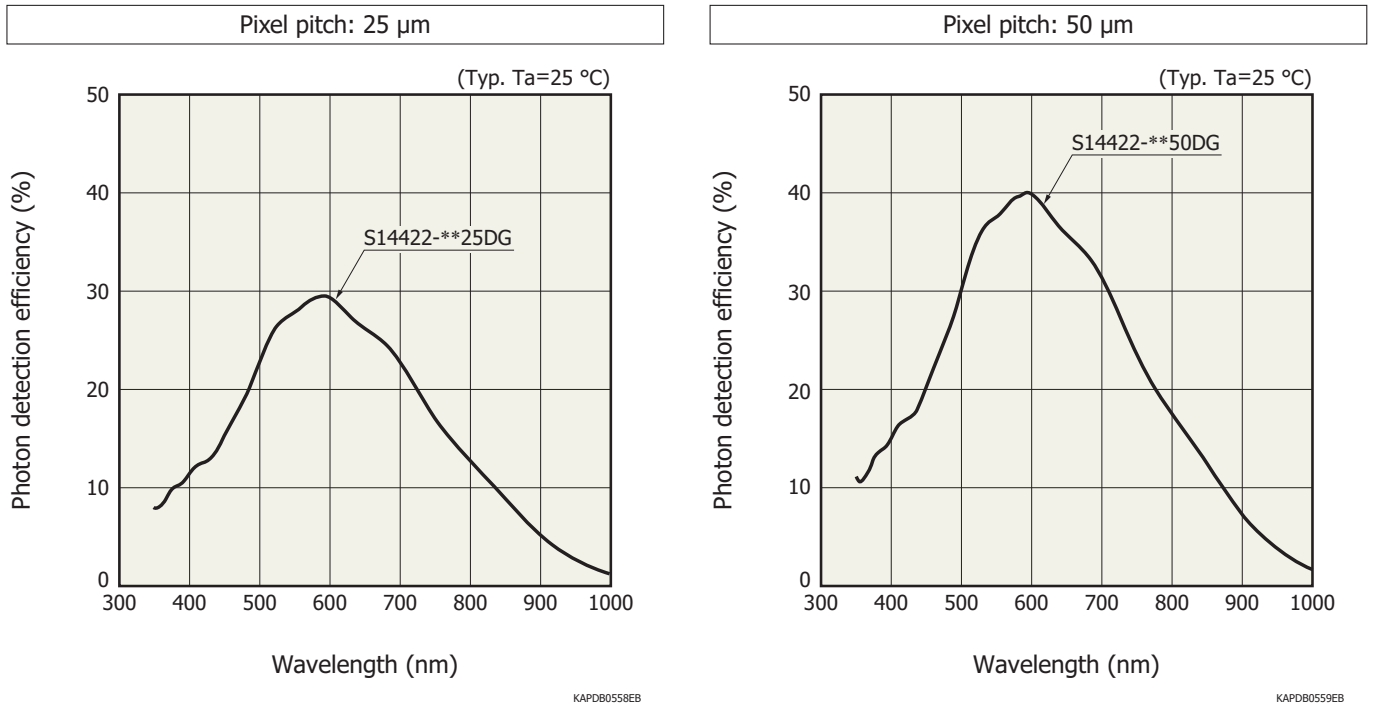

Photon detection efficiency does not include crosstalk or afterpulses.

Gain, crosstalk probability, photon detection efficiency vs. overvoltage characteristics (typical example)

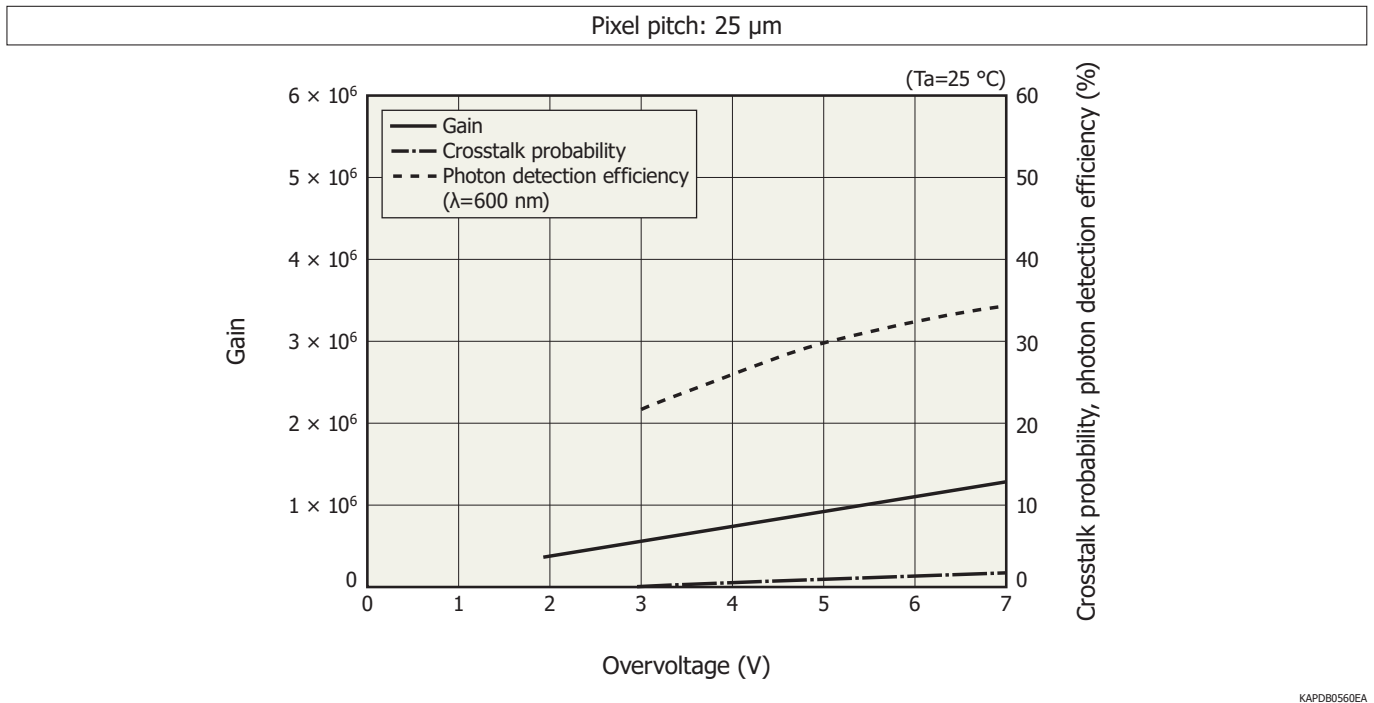

Pixel pitch: 50 μm

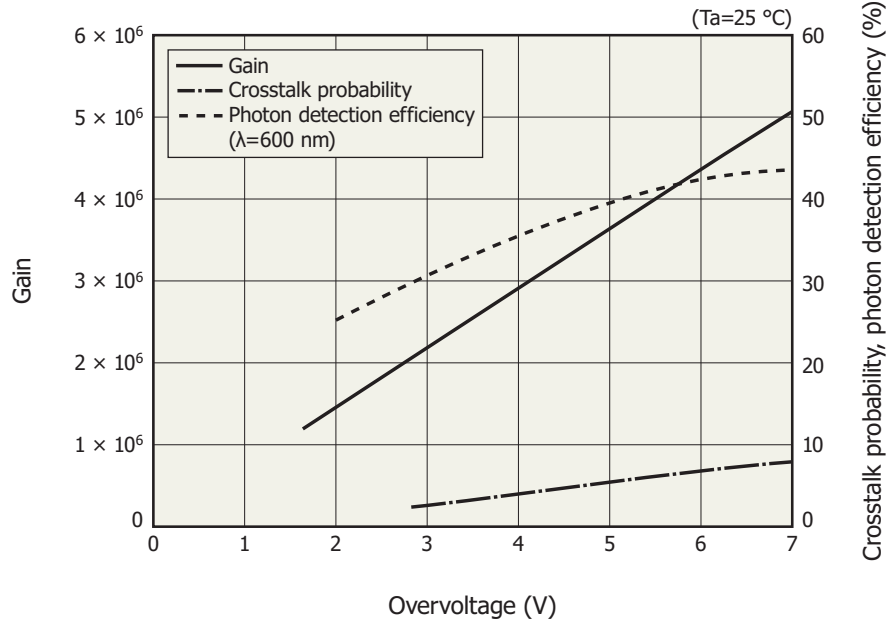

KAPD80561EA

MPPC characteristics vary with the operating voltage. Although increasing the operating voltage improves the photon detection efficiency and time resolution, it also increases the dark count and crosstalk at the same time, so an optimum operating voltage must be selected to match the application.

Current vs. voltage characteristics of TE-cooler

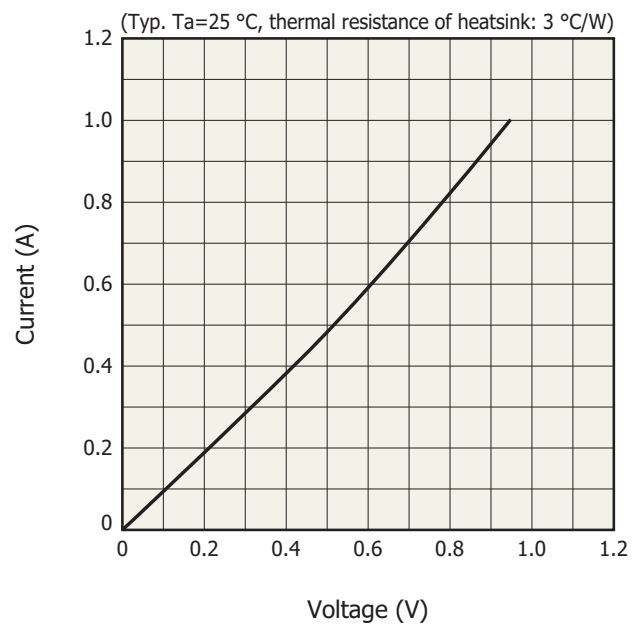

KAPDB0166EA

Thermistor temperature characteristics

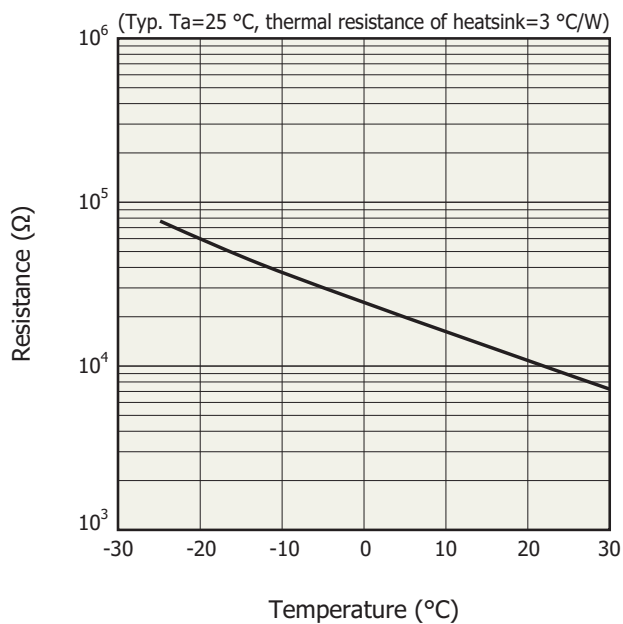

KAPDB0167EC

Cooling characteristics of TE-cooler

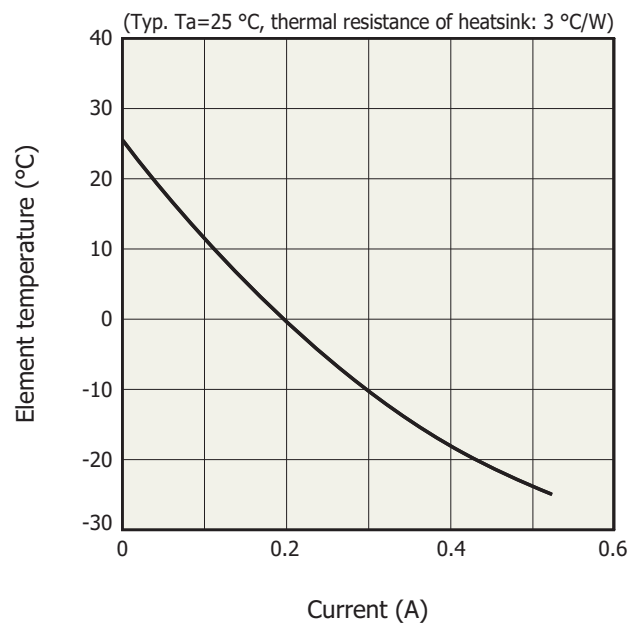

KAPDB0168ED

Dimensional outlines (unit: mm)

S14422-1525DG/-1550DG

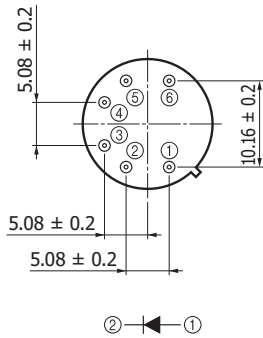
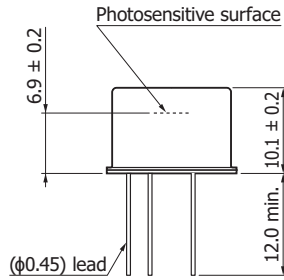
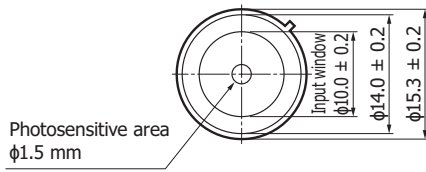

Tolerance unless otherwise noted: ± 0.2
Distance from photosensitive area center to cap center
 $-0.3 \leq X \leq +0.3$
 $-0.3 \leq Y \leq +0.3$

- ① Detector (anode)
- ② Detector (cathode)
- ③ TE-cooler (-)
- ④ TE-cooler (+)
- ⑤ ⑥ Thermistor

KAPDA0210EA

S14422-3025DG/-3050DG

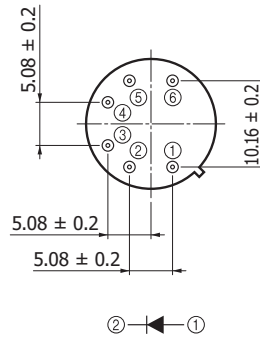
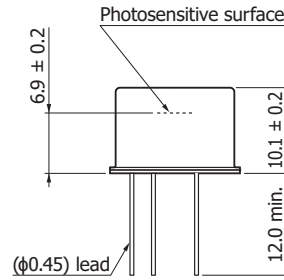
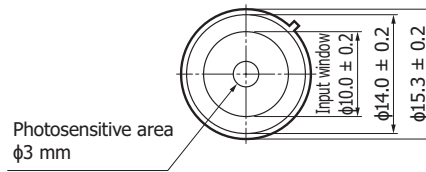

Tolerance unless otherwise noted: ± 0.2
Distance from photosensitive area center to cap center
 $-0.3 \leq X \leq +0.3$
 $-0.3 \leq Y \leq +0.3$

- ① Detector (anode)
- ② Detector (cathode)
- ③ TE-cooler (-)
- ④ TE-cooler (+)
- ⑤ ⑥ Thermistor

KAPDA0211EA

Precautions

- If necessary, incorporate appropriate protective circuits in power supplies, devices, and measuring instruments to prevent overvoltage and overcurrent.

Related information

www.hamamatsu.com/sp/ssd/doc_en.html

Precautions

- Disclaimer
- Metal, ceramic, plastic package products

MPPC modules C14455/C14456 series (GA type)

The C14455/C14456 series (GA type) are measurement modules capable of detecting low-level light using its built-in TE-cooled MPPC (S14422 series). These modules consist of a thermoelectrically cooled MPPC, an amplifier, a high-voltage power supply circuit, and a temperature control circuit. The photosensitive area is available in two sizes of $\phi 1.5$ mm and $\phi 3.0$ mm, and the signal output is analog. The modules operate just by connecting them to an external power supply (± 5 V). As the C14456 series is compact and lightweight, it is suitable for integration into devices (Heat dissipation measures are necessary).



C14455 series (GA type)

Block diagram

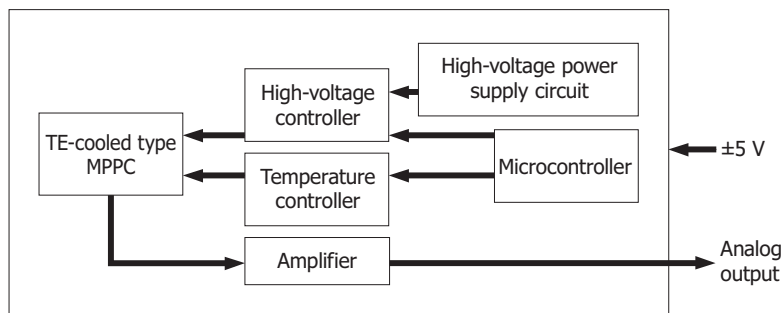

KACCC0680EA

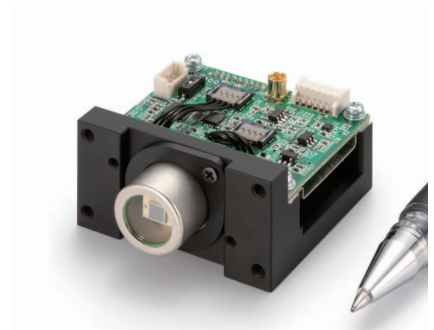

C14456 series (GA type)

MPPC is a registered trademark of Hamamatsu Photonics K.K.

Information described in this material is current as of January 2020.

Product specifications are subject to change without prior notice due to improvements or other reasons. This document has been carefully prepared and the information contained is believed to be accurate. In rare cases, however, there may be inaccuracies such as text errors. Before using these products, always contact us for the delivery specification sheet to check the latest specifications.

The product warranty is valid for one year after delivery and is limited to product repair or replacement for defects discovered and reported to us within that one year period. However, even if within the warranty period we accept absolutely no liability for any loss caused by natural disasters or improper product use. Copying or reprinting the contents described in this material in whole or in part is prohibited without our prior permission.

HAMAMATSU

www.hamamatsu.com

HAMAMATSU PHOTONICS K.K., Solid State Division

1126-1 Ichino-cho, Higashi-ku, Hamamatsu City, 435-8558 Japan, Telephone: (81)53-434-3311, Fax: (81)53-434-5184

U.S.A.: Hamamatsu Corporation: 360 Foothill Road, Bridgewater, N.J. 08807, U.S.A., Telephone: (1)908-231-0960, Fax: (1)908-231-1218, E-mail: usa@hamamatsu.com

Germany: Hamamatsu Photonics Deutschland GmbH: Arzbergerstr. 10, D-82211 Herrsching am Ammersee, Germany, Telephone: (49)8152-375-0, Fax: (49)8152-265-8, E-mail: info@hamamatsu.de

France: Hamamatsu Photonics France S.A.R.L.: 19, Rue du Saule Trapu, Parc du Moulin de Massy, 91882 Massy Cedex, France, Telephone: (33)1 69 53 71 00, Fax: (33)1 69 53 71 10, E-mail: infos@hamamatsu.fr

United Kingdom: Hamamatsu Photonics UK Limited: 2 Howard Court, 10 Tewin Road, Welwyn Garden City, Hertfordshire AL7 1BW, United Kingdom, Telephone: (44)1707-294888, Fax: (44)1707-325777, E-mail: info@hamamatsu.co.uk

North Europe: Hamamatsu Photonics Norden AB: Torshamnsgatan 35 16440 Kista, Sweden, Telephone: (46)8-509 031 00, Fax: (46)8-509 031 01, E-mail: info@hamamatsu.se

Italy: Hamamatsu Photonics Italia S.r.l.: Strada della Moia, 1 int. 6, 20020 Arese (Milano), Italy, Telephone: (39)02-93 58 17 33, Fax: (39)02-93 58 17 41, E-mail: info@hamamatsu.it

China: Hamamatsu Photonics (China) Co., Ltd.: B1201, Jiaming Center, No.27 Dongsanhuan Beilu, Chaoyang District, 100020 Beijing, P.R.China, Telephone: (86)10-6586-6006, Fax: (86)10-6586-2866, E-mail: hpc@hamamatsu.com.cn

Taiwan: Hamamatsu Photonics Taiwan Co., Ltd.: 8F-3, No. 158, Section2, Gongdao 5th Road, East District, Hsinchu, 300, Taiwan R.O.C. Telephone: (886)3-659-0080, Fax: (886)3-659-0081, E-mail: info@hamamatsu.com.tw