

Mini-spectrometers

[**TM series**]

| C10082CA/C10083CA series



High sensitivity type (integrated with back-thinned type CCD image sensor)

TM series mini-spectrometers are polychromators integrated with optical elements, an image sensor and a driver circuit. Light to be measured is guided into the entrance port of TM series through an optical fiber and the spectrum measured with the built-in image sensor is output from the USB port to a PC for data acquisition. They are high sensitivity mini-spectrometers employing a back-thinned type CCD image sensor. Their sensitivity is about two orders of magnitudes higher than CMOS type making TM series even more ideal for low-light-level measurement. The C10082CAH and C10083CAH are high resolution type (spectral resolution: 1 nm Typ.).

Mini-spectrometer TM series comes supplied with free evaluation software that allows setting measurement conditions, acquiring and saving data, and displaying graphs. Original measurement software can be designed on an end-user's side as DLL's function specification is disclosed.

Features

- **Integrated with back-thinned type CCD image sensor: Sensitivity is about two orders of magnitude higher than CMOS type.**
- **High resolution: 1 nm (C10082CAH, C10083CAH)**
- **Variable spectral resolution by selecting slit width and NA**
- **High throughput due to transmission grating made of quartz**
- **Easy to install into equipment**
- **Wavelength conversion factor*1 is recorded in internal memory.**
- **Supports external trigger input*2**

*1: A conversion factor for converting the image sensor pixel number into a wavelength is recorded in the module. A calculation factor for converting the A/D converted count into the input light intensity is not provided.

*2: Coaxial cable for external trigger input is sold separately. Refer to the "Mini-spectrometers Selection Guide" for details on external triggers.

Applications

- **Low-light-level measurement such as fluorescence measurement**
- **Semiconductor process control**
- **Evaluation of light source characteristics such as LED**

Comparison of CCD type and CMOS type

Output comparison (relative value)

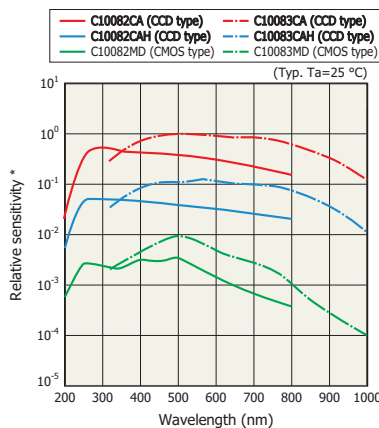

* A/D count when constant light level enters optical fiber
(Fiber core diameter: 600 μm, assuming no attenuation in optical fiber)

KACCB0168EB

Measurable optical power entering optical fiber

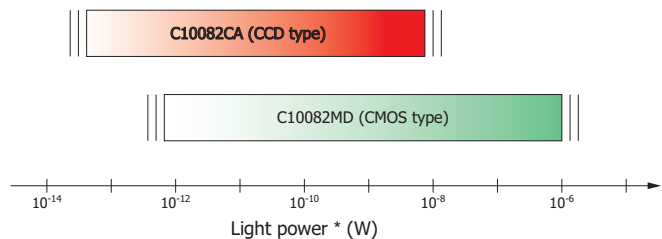

* Fiber core diameter: 600 μm, assuming no attenuation in optical fiber

KACCB0146EB

Optical characteristics

Parameter	TM-UV/VIS-CCD		TM-VIS/NIR-CCD		Unit
	C10082CA	C10082CAH	C10083CA	C10083CAH	
Spectral response range	200 to 800		320 to 1000		nm
Spectral resolution (FWHM) ^{*3}	6 max.	1 typ.	8 ^{*4} max.	1 ^{*4} typ.	nm
Wavelength reproducibility ^{*5}	-0.2 to +0.2				nm
Wavelength temperature dependence	-0.04 to +0.04				nm/°C
Spectral stray light ^{*3 *6}	-33 max.		-30 max.		dB

*3: Depends on the slit opening. Values were measured with the slit listed in the table "Structure / Absolute maximum ratings".

*4: $\lambda=320$ to 900 nm

*5: Measured under constant light input conditions

*6: When monochromatic light of the following wavelengths is input, spectral stray light is defined as the ratio of the count measured at the input wavelength, to the count measured in a region of the input wavelength ± 40 nm.

C10082CA/C10082CAH: 500 nm, C10083CA/C10083CAH: 650 nm

Electrical characteristics

Parameter	Specification	Unit
A/D conversion	16	bits
Integration time	10 to 10000	ms
Interface	USB 1.1	-
USB bus power current consumption	100 max.	mA
External power supply	5	V
Consumption current of external power supply	0.8 max.	A

Structure / Absolute maximum ratings

Parameter	Specification				Unit
Dimensions (W × D × H)	95 × 92 × 76				mm
Weight	685				g
Image sensor	Back-thinned type CCD image sensor (S10420-1106-01)				-
Number of pixels	2048				pixels
Slit ^{*7} (H × V)	70 × 800	10 × 1000	70 × 800	10 × 1000	μm
NA ^{*8}	0.22	0.11	0.22	0.11	-
Connector for optical fiber	SMA905D				-
Operating temperature ^{*9}	+5 to +40				°C
Storage temperature ^{*9}	-20 to +70				°C

*7: Entrance slit aperture size

*8: Numeric aperture (solid angle)

*9: No dew condensation

When there is a temperature difference between a product and the surrounding area in high humidity environment, dew condensation may occur on the product surface. Dew condensation on the product may cause deterioration in characteristics and reliability.

Note: Exceeding the absolute maximum ratings even momentarily may cause a drop in product quality. Always be sure to use the product within the absolute maximum ratings.

Product line-up

TM series includes the following models. Spectral resolution of each model differs according to the slit width and NA.

Type no.		NA	Slit width
Spectral response range 200 to 800 nm	Spectral response range 320 to 1000 nm		
C10082CA-2200	C10083CA-2200	0.22	200 μm
C10082CA-2100	C10083CA-2100	0.22	100 μm
C10082CA	C10083CA	0.22	70 μm
C10082CA-2050	C10083CA-2050	0.22	50 μm
C10082CA-1050	C10083CA-1050	0.11	50 μm
C10082CA-1025	C10083CA-1025	0.11	25 μm
C10082CAH	C10083CAH	0.11	10 μm

Spectral resolution vs. wavelength

C10082CA series

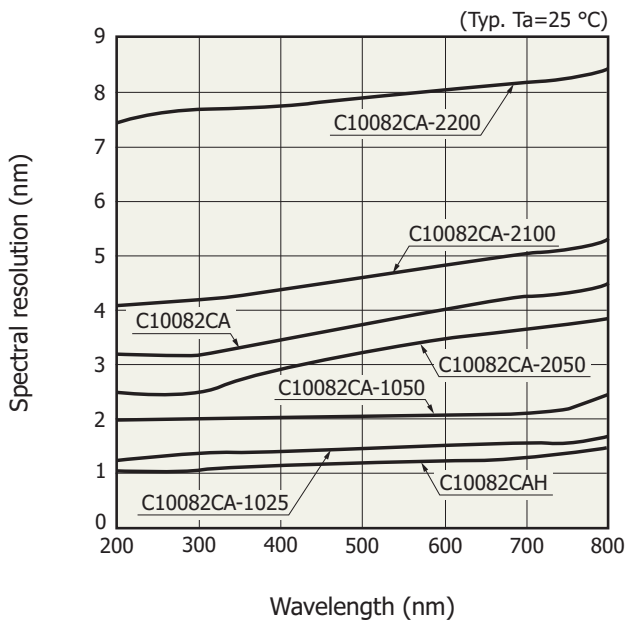

C10083CA series

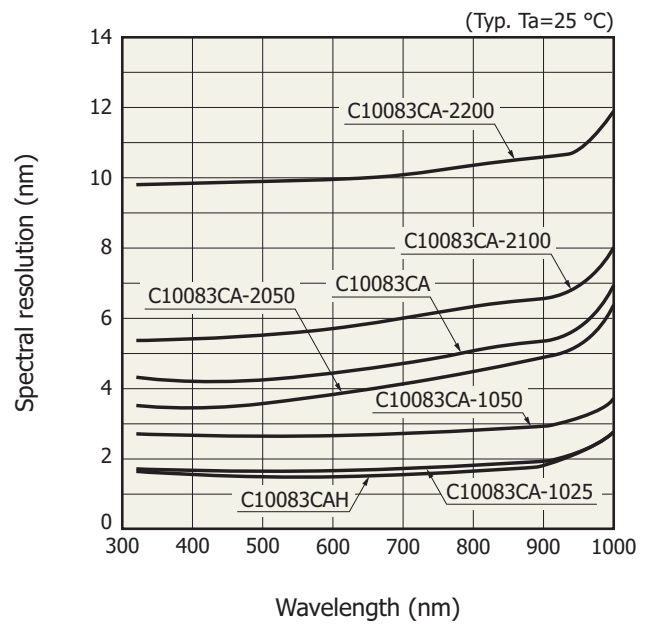

Output characteristics

C10082CA series

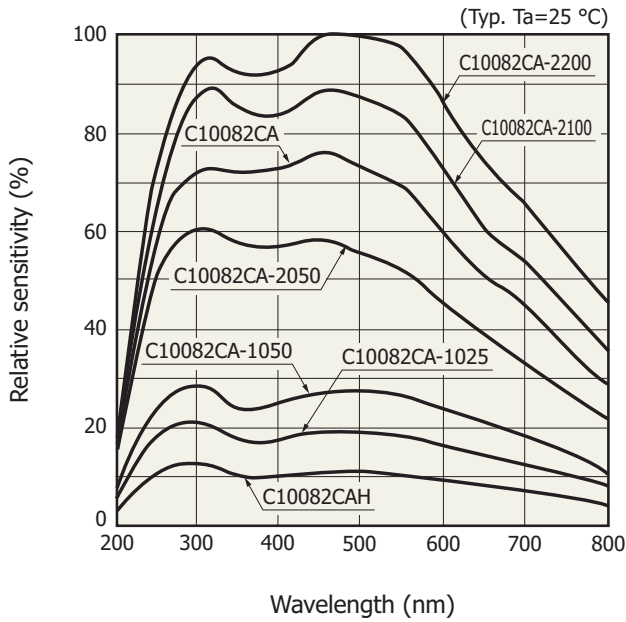

C10083CA series

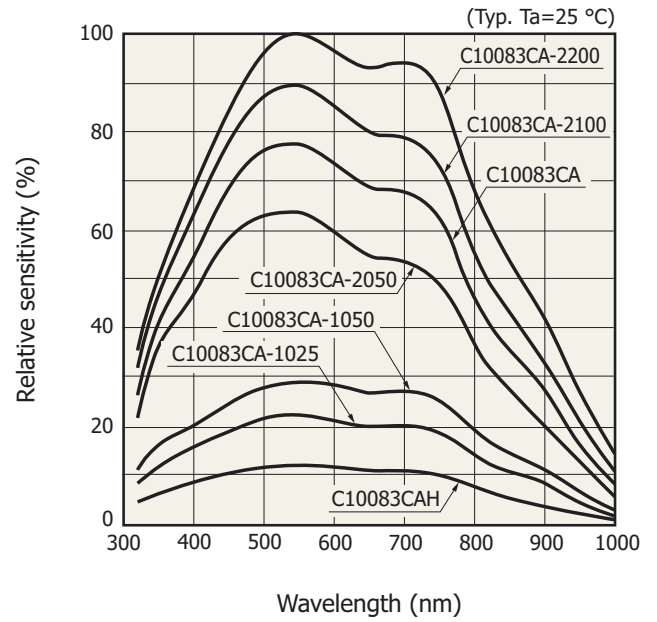

Linearity (typical example)

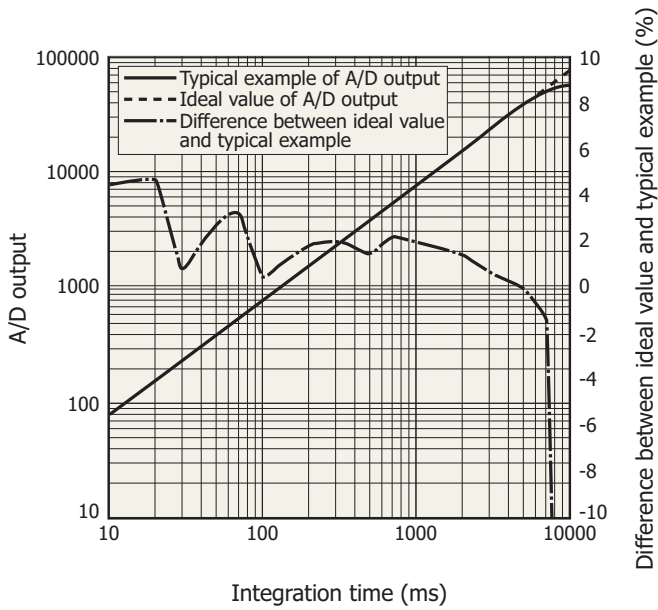

KACCB0235EA

A/D output is the output with dark output is subtracted when light is input. The difference between the ideal value and typical example contains a measurement error. The smaller the A/D output, the larger the measurement error.

Dark output vs. ambient temperature (typical example)

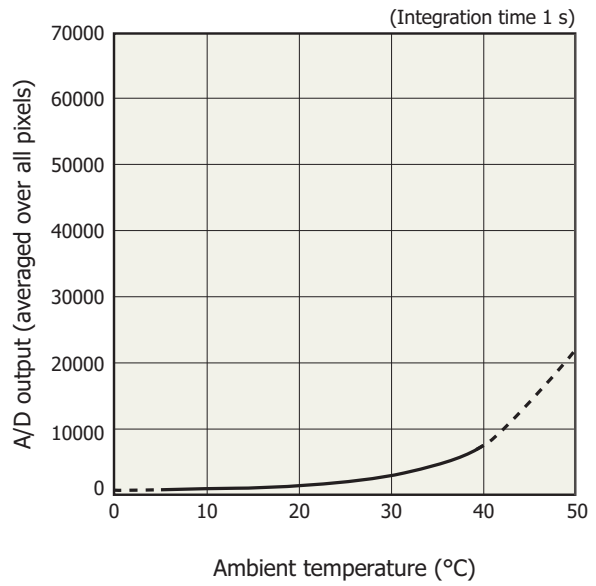

KACCB0237EA

A/D output is the sum of the sensor and circuit offset outputs and the sensor dark output.

Optical component layout

TM series mini-spectrometers use a transmission holographic grating made of quartz and precision optical components arranged on a rugged optical base, making it possible to deliver high throughput and highly accurate optical characteristics.

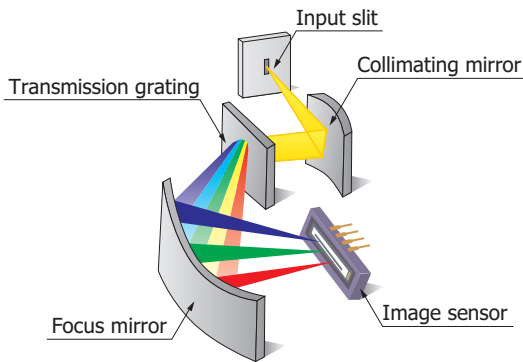

KACCC0287EA

Connection example (transmission light measurement)

Light to be measured is guided into the entrance port of TM series through an optical fiber and the spectrum measured with the built-in image sensor is output through the USB port to a PC for data acquisition. There are no moving parts inside the unit so stable measurements are obtained at all times. An optical fiber that guides light input from external sources allows a flexible measurement setup.

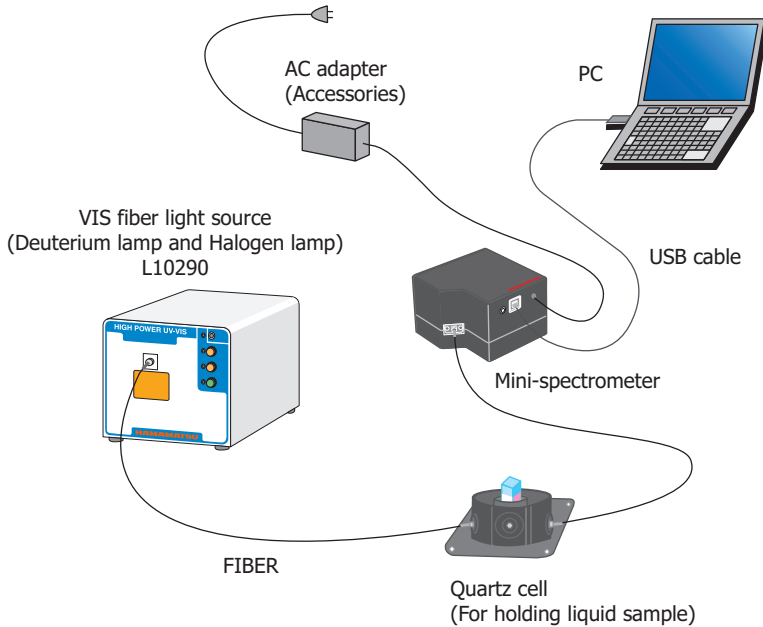

KACCC0317EB

Evaluation software package (supplied with unit)

Installing the evaluation software package (Spec Evaluation.exe)^{*10} into your PC allows running the following basic tasks:

- Measurement data acquisition and save
- Measurement condition setup
- Module information acquisition (wavelength conversion factor, polychromator type, etc.)
- Graphic display
- Arithmetic operation
 - Pixel number to wavelength conversion
 - Comparison calculation with reference data (transmittance, reflectance)
 - Dark subtraction
 - Gaussian approximation (peak position and count, FWHM)

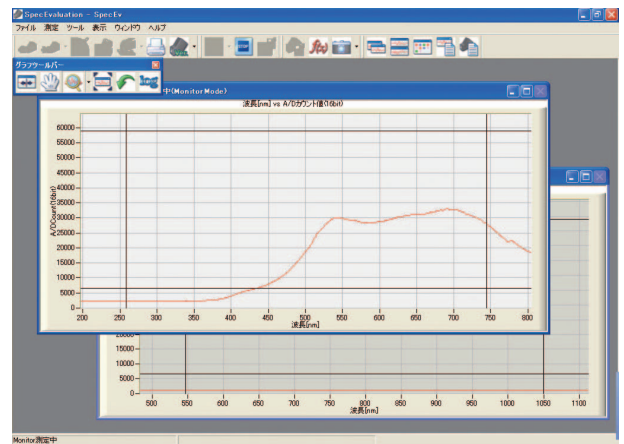

Note:

- Two or more mini-spectrometers can be connected and used with one PC simultaneously.
- The external trigger input function does not work with the evaluation software. If using an external trigger input or designing original application software, the user software must be configured to support that function.

*10: Compatible OS: Microsoft® Windows® 7 Professional SP1 (32-bit, 64-bit)
Microsoft® Windows® 8 Professional (32-bit, 64-bit)

DLL for controlling hardware is also provided.

You can develop your own measurement programs by using a following software development environment.

Microsoft® Visual Studio® 2008 (SP1) Visual C++®

Microsoft® Visual Studio® 2008 (SP1) Visual Basic®

Note: Microsoft, Windows, Visual Studio, Visual C++ and Visual Basic are either registered trademarks or trademarks of Microsoft Corporation in the United States and other countries.

Measurement example (C10083CA)

Fluorescence measurement of quinine solution (1000 ppm)

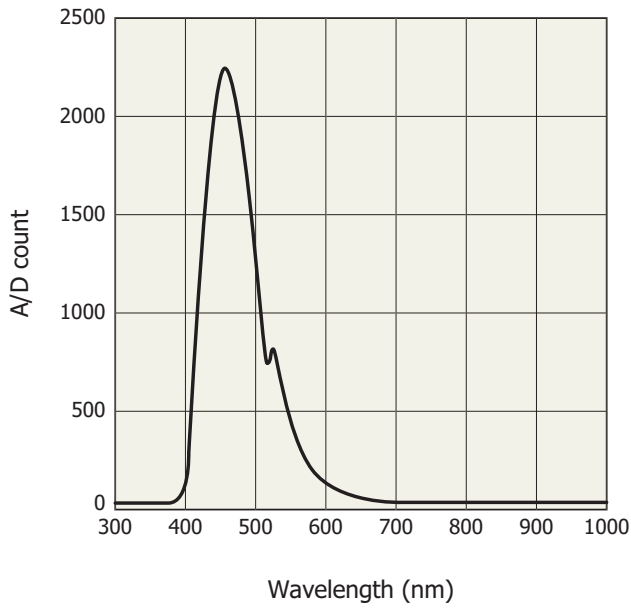

KACCB0145EA

Dimensional outline (unit: mm)

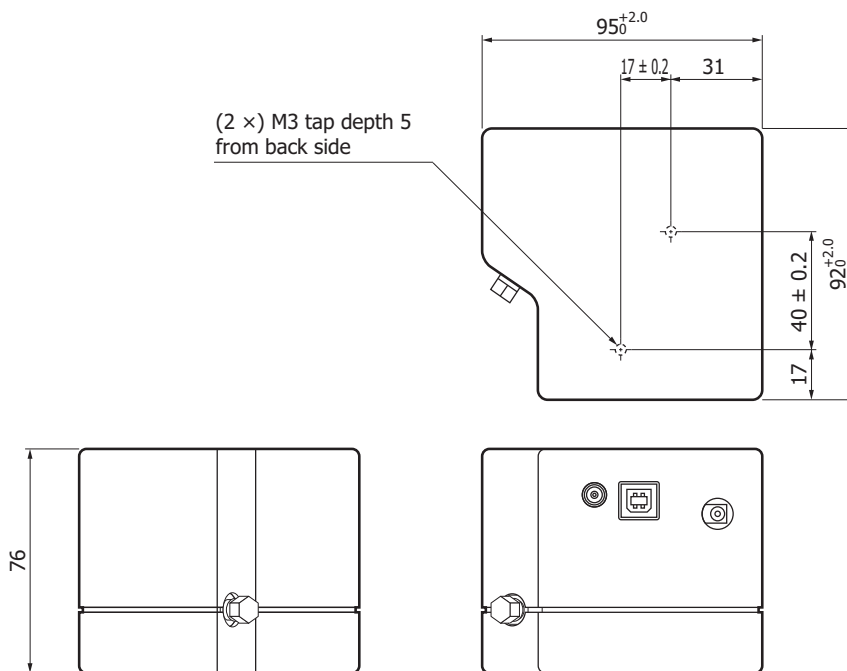

Tolerance unless otherwise noted: ±0.5
Weight: 685 g

KACCA0188EF

Accessories

- USB cable
- Dedicated software (evaluation software, sample software, DLL)
- AC adapter (for power supply)

Options (sold separately)

- Optical fiber for light input

Type no.	Product name	Applicable mini-spectrometer	Core diameter (μm)	Specification
A9762-01	Fiber for UV/visible range (resistance to UV)	C10082CA series (TM-UV/VIS-CCD) C10083CA series (TM-VIS/NIR-CCD)	600	NA=0.22, length 1.5 m, connectorized SMA905D at both ends

- Coaxial cable for external trigger input A10670

Dimensional outline (unit: mm)

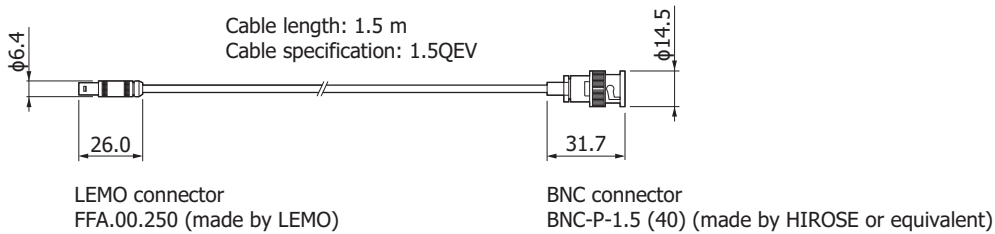

KACCA0220EB

Mini-spectrometer lineup

Type no.	Type	Spectral response range (nm)													Spectral resolution max. (nm)	Image sensor		
		200	400	600	800	1000	1200	1400	1600	1800	2000	2200	2400	2600				
C10082CA	TM-UV/VIS-CCD High sensitivity																6	Back-thinned CCD image sensor
C10082CAH	TM-UV/VIS-CCD High resolution		200 to 800														1*	
C10082MD	TM-UV/VIS-MOS Wide dynamic range																6	
C10083CA	TM-VIS/NIR-CCD High sensitivity																8 (λ=320 to 900 nm)	Back-thinned CCD image sensor
C10083CAH	TM-VIS/NIR-CCD High resolution																1* (λ=320 to 900 nm)	
C10083MD	TM-VIS/NIR-MOS Wide dynamic range																8	CMOS linear image sensor
C11697MB	TM-VIS/NIR-MOS-II Trigger-compatible																8	High-sensitivity CMOS linear image sensor
C9404CA	TG-UV-CCD High sensitivity		200 to 400														3	Back-thinned CCD image sensor
C9404CAH	TG-UV-CCD High resolution																1*	
C9405CB	TG-SWNIR-CCD-II IR-enhanced																5 (λ=550 to 900 nm)	IR-enhanced back-thinned CCD image sensor
C11713CA	TG-RAMAN-I High resolution																0.3*	Back-thinned CCD image sensor
C11714CB	TG-RAMAN-II High resolution																0.3*	IR-enhanced back-thinned CCD image sensor
C11482GA	TG2-NIR Non-cooled type																7	InGaAs linear image sensor
C9913GC	TG-cooled NIR-I Low noise (cooled type)																7	
C9914GB	TG-cooled NIR-II Low noise (cooled type)																8	
C11118GA	TG-cooled NIR-III Low noise (cooled type)																20	
C13053MA	FT-SWIR-MOS-II Compact, thin case																3.5	High-sensitivity CMOS linear image sensor
C13054MA	FT2-RAMAN Compact, thin case																0.4*	
C11007MA	RC-VIS-MOS Spectrometer module																9	CMOS linear image sensor
C11008MA	RC-SWNIR-MOS Spectrometer module																8	IR-enhanced CMOS linear image sensor

* Typ.

For installation into mobile measuring equipment

Type no.	Type	Spectral response range (nm)													Spectral resolution max. (nm)	Image sensor		
		200	400	600	800	1000	1200	1400	1600	1800	2000	2200	2400	2600				
C11009MA	RC-VIS-MOS Spectrometer head																9	CMOS linear image sensor
C11010MA	RC-SWNIR-MOS Spectrometer head																8	IR-enhanced CMOS linear image sensor

For installation into mobile measuring equipment (ultra-compact)

Type no.	Type	Spectral response range (nm)													Spectral resolution max. (nm)	Image sensor		
		200	400	600	800	1000	1200	1400	1600	1800	2000	2200	2400	2600				
C11708MA	MS-SWNIR-MOS Spectrometer head																20	CMOS linear image sensor
C12666MA	Spectrometer head																15	CMOS linear image sensor
C12880MA	Spectrometer head																15	High-sensitivity CMOS linear image sensor

Related information

http://www.hamamatsu.com/sp/ssd/doc_en.html

■ Precautions

- Disclaimer
- Mini-spectrometers

■ Technical information

- Mini-spectrometers

Information described in this material is current as of October, 2015.

Product specifications are subject to change without prior notice due to improvements or other reasons. This document has been carefully prepared and the information contained is believed to be accurate. In rare cases, however, there may be inaccuracies such as text errors. Before using these products, always contact us for the delivery specification sheet to check the latest specifications.

The product warranty is valid for one year after delivery and is limited to product repair or replacement for defects discovered and reported to us within that one year period. However, even if within the warranty period we accept absolutely no liability for any loss caused by natural disasters or improper product use. Copying or reprinting the contents described in this material in whole or in part is prohibited without our prior permission.

HAMAMATSU

www.hamamatsu.com

HAMAMATSU PHOTONICS K.K., Solid State Division

1126-1 Ichino-cho, Higashi-ku, Hamamatsu City, 435-8558 Japan, Telephone: (81) 53-434-3311, Fax: (81) 53-434-5184

U.S.A.: Hamamatsu Corporation: 360 Foothill Road, Bridgewater, N.J. 08807, U.S.A., Telephone: (1) 908-231-0960, Fax: (1) 908-231-1218

Germany: Hamamatsu Photonics Deutschland GmbH: Arzbergerstr. 10, D-82211 Herrsching am Ammersee, Germany, Telephone: (49) 8152-375-0, Fax: (49) 8152-265-8

France: Hamamatsu Photonics France S.A.R.L.: 19, Rue du Saule Trapu, Parc du Moulin de Massy, 91882 Massy Cedex, France, Telephone: 33-(1) 69 53 71 00, Fax: 33-(1) 69 53 71 10

United Kingdom: Hamamatsu Photonics UK Limited: 2 Howard Court, 10 Tewin Road, Welwyn Garden City, Hertfordshire AL7 1BW, United Kingdom, Telephone: (44) 1707-294888, Fax: (44) 1707-325777

North Europe: Hamamatsu Photonics Norden AB: Torshamnsgatan 35 16440 Kista, Sweden, Telephone: (46) 8-509-031-00, Fax: (46) 8-509-031-01

Italy: Hamamatsu Photonics Italia S.r.l.: Strada della Moia, 1 int. 6, 20020 Arese (Milano), Italy, Telephone: (39) 02-93581733, Fax: (39) 02-93581741

China: Hamamatsu Photonics (China) Co., Ltd.: B1201, Jiaming Center, No.27 Dongsanhuan Beilu, Chaoyang District, Beijing 100020, China, Telephone: (86) 10-6586-6006, Fax: (86) 10-6586-2866