

Infrared LED

L5276, L5586, L6286

Subminiature LED

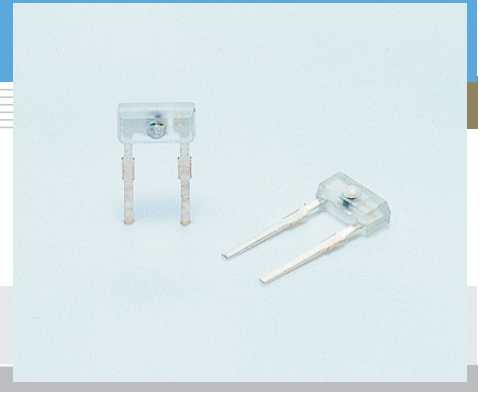

L5276, L5586 and L6286 are infrared LED molded into a subminiature, clear plastic package.

Features

- Peak emission wavelength
L5276 : 880 nm
L5586, L6286: 940 nm
- L6286: High output power
- Subminiature plastic package with lens

Applications

- Optical switches
- Cameras
- Encoders

■ Absolute maximum ratings (Ta=25 °C)

Parameter	Symbol	Condition	Value	Unit
Forward current	IF		50	mA
Reverse voltage	VR		5	V
Pulse forward current	IFP	Pulse width: 100 μs Duty ratio: 1 %	0.5	A
Power dissipation	Po		80	mW
Operating temperature	Topr		-25 to +85	°C
Storage temperature	Tstg		-30 to +85	°C
Soldering	-		260 °C, 3 s at least 2.5 mm away from package surface	-

■ Electrical and optical characteristics (Ta=25 °C)

Parameter	Symbol	Condition	L5276			L5586			L6286			Unit
			Min.	Typ.	Max.	Min.	Typ.	Max.	Min.	Typ.	Max.	
Peak emission wavelength	λ_p	IF=20 mA	-	880	-	-	940	-	-	940	-	nm
Spectral half width	$\Delta\lambda$	IF=20 mA	-	50	-	-	45	-	-	45	-	nm
Forward voltage	VF	IF=20 mA	-	1.3	1.6	-	1.25	1.45	-	1.25	1.45	V
Reverse current	IR	VR=5 V	-	-	10	-	-	10	-	-	10	μA
Radiant flux	ϕ_e	IF=20 mA	1.0	2.2	-	0.5	-	-	0.8	-	-	mW
Terminal capacitance	Ct	VR=0 V, f=1 MHz	-	30	-	-	20	-	-	20	-	pF

■ Emission spectrum

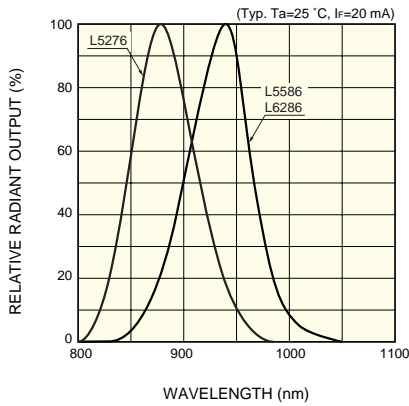

KLEDB0291EA

■ Radiant flux vs. forward current

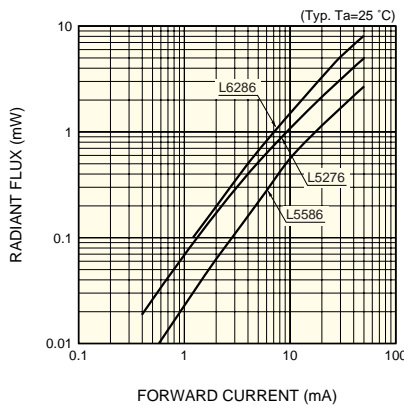

KLEDB0292EA

■ Forward current vs. forward voltage

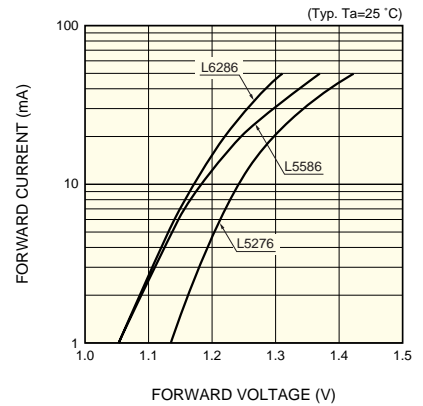

KLEDB0293EA

■ Directivity

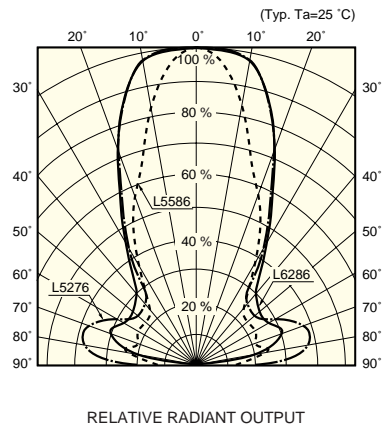

KLEDB0108EA

■ Radiant output vs. ambient temperature

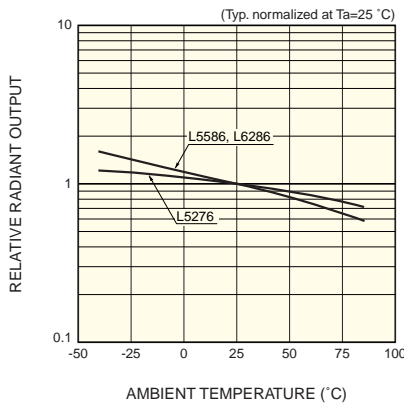

KLEDB0109EA

■ Allowable forward current vs. ambient temperature

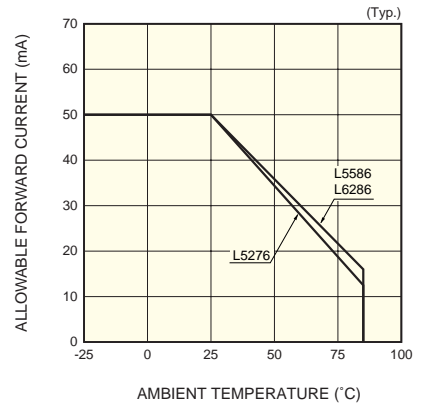

KLEDB0110EA

■ Pulse forward current vs. duty ratio

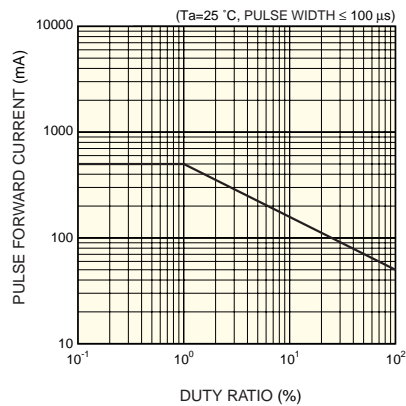

KLEDB0111EA

■ Dimensional outline (unit: mm)

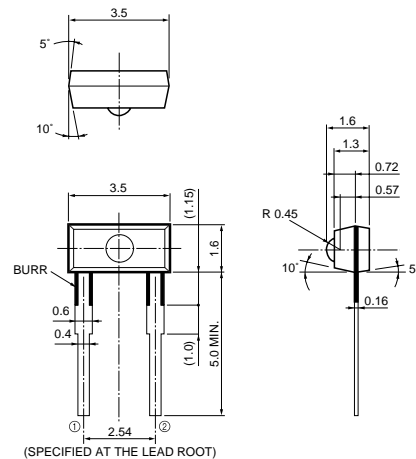

① ← → ②

Shaded area indicates burr.
Tolerance unless otherwise noted: ±0.2, ±2°
Values in parentheses are not guaranteed,
but for reference.

KLEDA0023EA

HAMAMATSU

Information furnished by HAMAMATSU is believed to be reliable. However, no responsibility is assumed for possible inaccuracies or omissions. Specifications are subject to change without notice. No patent rights are granted to any of the circuits described herein. ©2006 Hamamatsu Photonics K.K.

HAMAMATSU PHOTONICS K.K., Solid State Division

1126-1 Ichino-cho, Higashi-ku, Hamamatsu City, 435-8558 Japan, Telephone: (81) 53-434-3311, Fax: (81) 53-434-5184, www.hamamatsu.com

U.S.A.: Hamamatsu Corporation: 360 Foothill Road, P.O.Box 6910, Bridgewater, N.J. 08807-0910, U.S.A., Telephone: (1) 908-231-0960, Fax: (1) 908-231-1218

Germany: Hamamatsu Photonics Deutschland GmbH: Arzbergerstr. 10, D-82211 Herrsching am Ammersee, Germany, Telephone: (49) 08152-3750, Fax: (49) 08152-2658

France: Hamamatsu Photonics France S.A.R.L.: 19, Rue du Saule Trappu, Parc du Moulin de Massy, 91882 Massy Cedex, France, Telephone: 33-(1) 69 53 71 00, Fax: 33-(1) 69 53 71 10

United Kingdom: Hamamatsu Photonics UK Limited: 2 Howard Court, 10 Tewin Road, Welwyn Garden City, Hertfordshire AL7 1BW, United Kingdom, Telephone: (44) 1707-294888, Fax: (44) 1707-325777

North Europe: Hamamatsu Photonics Norden AB: Smidesvägen 12, SE-171 41 Solna, Sweden, Telephone: (46) 8-509-031-00, Fax: (46) 8-509-031-01

Italy: Hamamatsu Photonics Italia S.R.L.: Strada della Moia, 1/E, 20020 Arese, (Milano), Italy, Telephone: (39) 02-935-81-733, Fax: (39) 02-935-81-741