

L7560-04

High-speed, high output power LED with mini-lens

The L7560-04 is a high-speed, high-power LED with a micro-ball lens bonded to the surface of the LED chip having an internal confinement structure. In addition to the micro-ball lens, the LED chip is sealed with a cap with a mini-lens to make the output beam even narrower. This allows highly efficient input of the beam into an optical fiber, making the L7560-04 well suited for optical fiber communications.

Features

- High-speed response: 100 MHz typ. (I_F=50 mA)
- High light output: 30 μW typ. (I_F=50 mA, GI 50)

Applications

- Optical fiber communications
- Optical rangefinders

Absolute maximum ratings (T_a=25 °C)

Parameter	Symbol	Condition	Specification	Unit
Forward current	I _F		70	mA
Reverse voltage	V _R		3	V
Pulse forward current	I _{FP} max	Pulse width=10 μs Duty ratio=1%	0.25	A
Power dissipation	P		150	mW
Operating temperature	T _{opr}		-30 to +85	°C
Storage temperature	T _{stg}		-40 to +100	°C
Soldering conditions	-		260 °C or less, within 5 s, at least 1 mm away from lead root	-

Note: Exceeding the absolute maximum ratings even momentarily may cause a drop in product quality. Always be sure to use the product within the absolute maximum ratings.

Electrical and optical characteristics (T_a=25 °C)

Parameter	Symbol	Condition	Min.	Typ.	Max.	Unit
Peak emission wavelength	λ _p	I _F =50 mA	820	850	880	nm
Spectral half-width	Δλ	I _F =50 mA	-	50	80	nm
Forward voltage	V _F	I _F =50 mA	-	1.8	2.0	V
Pulse forward voltage	V _{FP}	I _F =0.25 A	-	2.7	4.0	V
Reverse current	I _R	V _R =3 V	-	-	20	μA
Fiber end output	P _f	I _F =50 mA, GI 50	20	30	-	μW
Cutoff frequency*1	f _c	I _F =50 mA + 1 mAp-p	70	100	-	MHz

*1: Frequency at which the light output drops by 3 dB relative to the output at 100 kHz

Emission spectrum

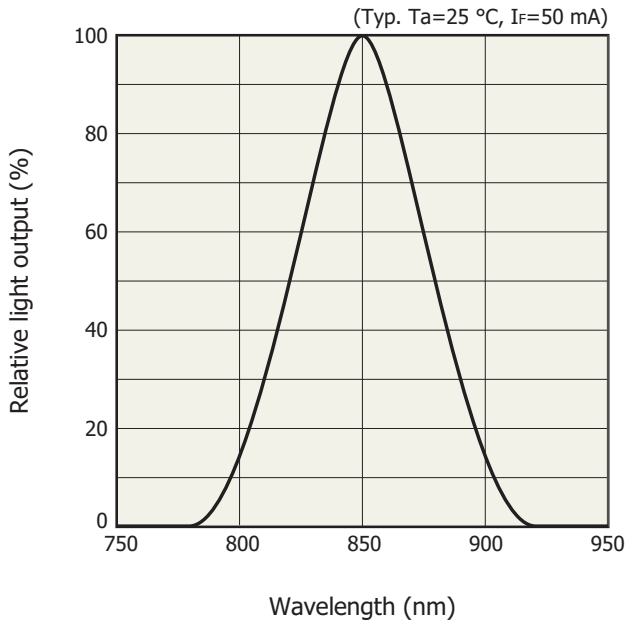

KLEDB0172EB

Fiber end output vs. forward current

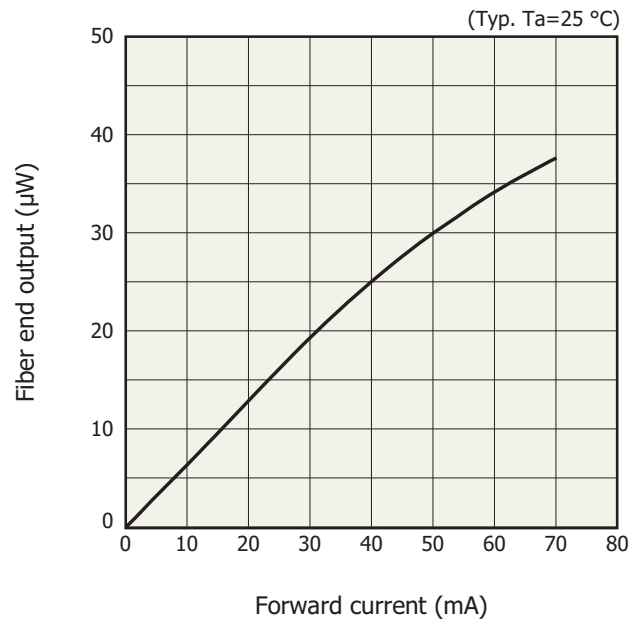

KLEDB0378EA

Forward current vs. forward voltage

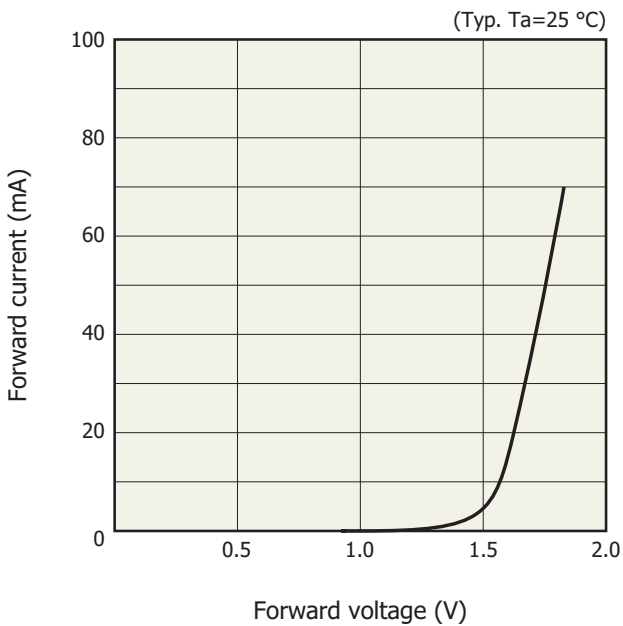

KLEDB0174EA

Frequency characteristics

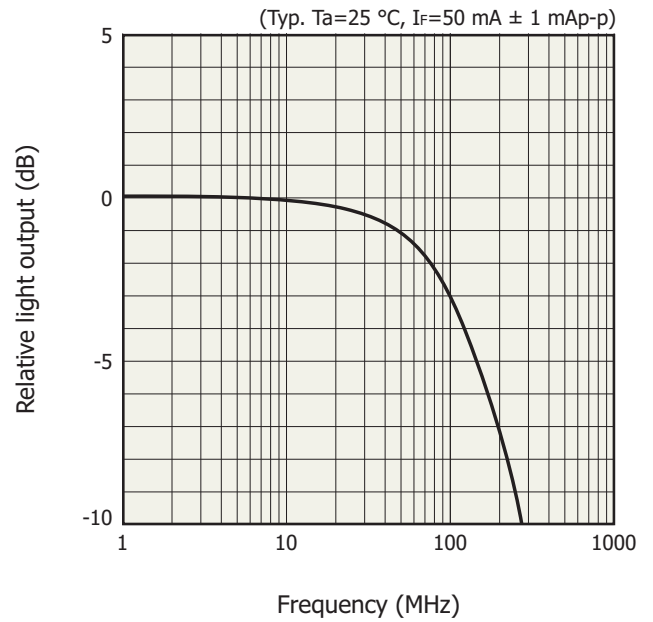

KLEDB0320EA

Fiber coupling characteristics (GI 50)

X, Y axes

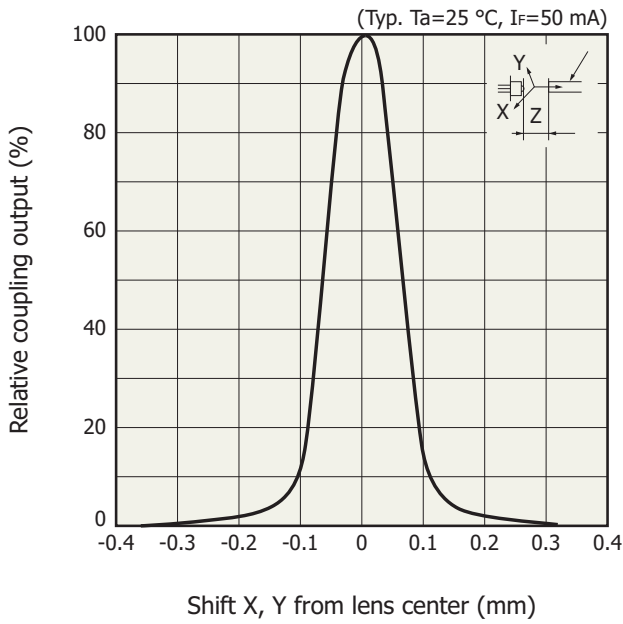

Z axis

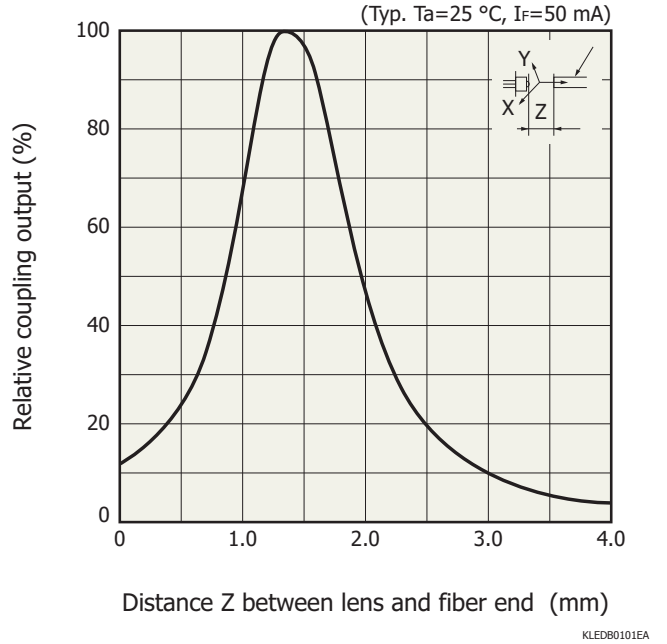

Light output vs. ambient temperature

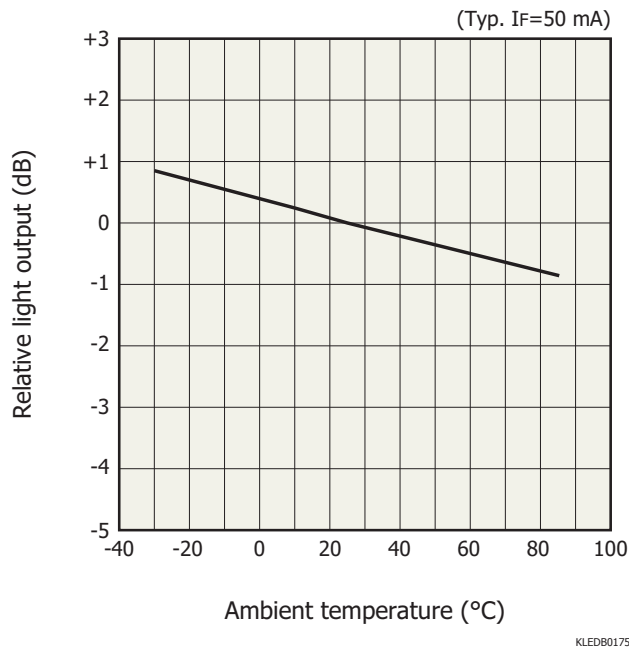

Allowable forward current vs. ambient temperature

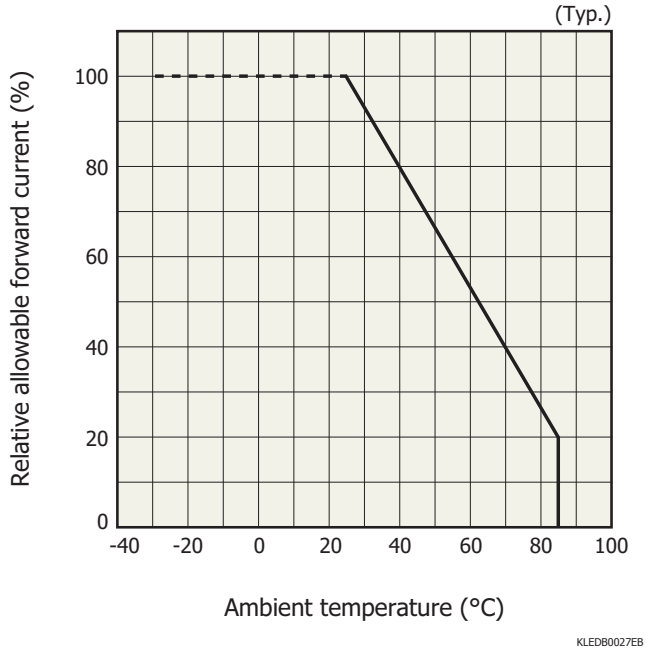

Allowable forward current vs. duty ratio

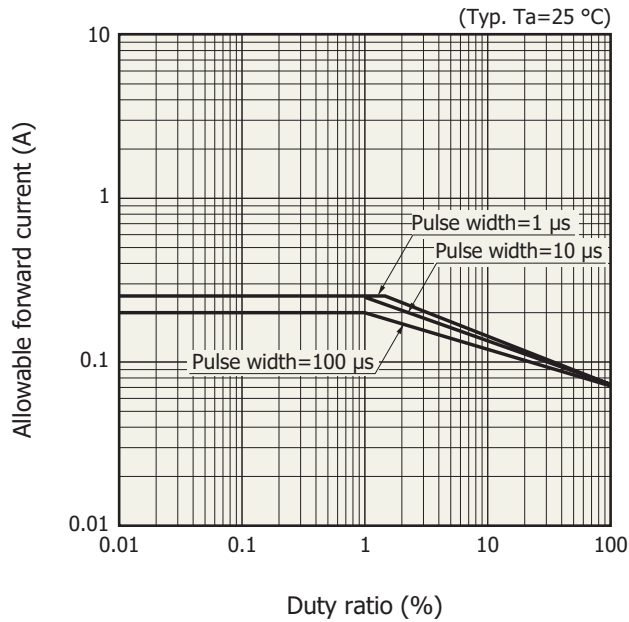

KLED0176EA

Dimensional outline (unit: mm)

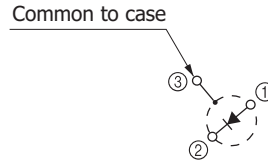
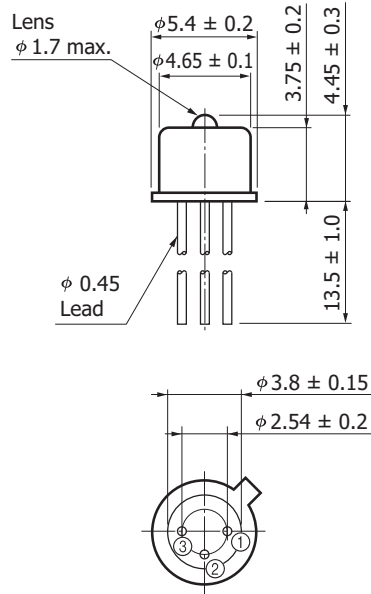

Standard packing: Conductive tray (100 pcs/tray)

KLEDA0097EA

Information described in this material is current as of April, 2013.

Product specifications are subject to change without prior notice due to improvements or other reasons. This document has been carefully prepared and the information contained is believed to be accurate. In rare cases, however, there may be inaccuracies such as text errors. Before using these products, always contact us for the delivery specification sheet to check the latest specifications.

The product warranty is valid for one year after delivery and is limited to product repair or replacement for defects discovered and reported to us within that one year period. However, even if within the warranty period we accept absolutely no liability for any loss caused by natural disasters or improper product use.

Copying or reprinting the contents described in this material in whole or in part is prohibited without our prior permission.

HAMAMATSU

www.hamamatsu.com

HAMAMATSU PHOTONICS K.K., Solid State Division

1126-1 Ichino-cho, Higashi-ku, Hamamatsu City, 435-8558 Japan, Telephone: (81) 53-434-3311, Fax: (81) 53-434-5184

U.S.A.: Hamamatsu Corporation: 360 Foothill Road, P.O.Box 6910, Bridgewater, N.J. 08807-0910, U.S.A., Telephone: (1) 908-231-0960, Fax: (1) 908-231-1218

Germany: Hamamatsu Photonics Deutschland GmbH: Arzbergerstr. 10, D-82211 Herrsching am Ammersee, Germany, Telephone: (49) 8152-375-0, Fax: (49) 8152-265-8

France: Hamamatsu Photonics France S.A.R.L.: 19, Rue du Saule Trapu, Parc du Moulin de Massy, 91882 Massy Cedex, France, Telephone: 33-(1) 69 53 71 00, Fax: 33-(1) 69 53 71 10

United Kingdom: Hamamatsu Photonics UK Limited: 2 Howard Court, 10 Tewin Road, Welwyn Garden City, Hertfordshire AL7 1BW, United Kingdom, Telephone: (44) 1707-294888, Fax: (44) 1707-325777

North Europe: Hamamatsu Photonics Norden AB: Thorshamnsgatan 35 16440 Kista, Sweden, Telephone: (46) 8-509-031-00, Fax: (46) 8-509-031-01

Italy: Hamamatsu Photonics Italia S.R.L.: Strada della Moia, 1 int. 6, 20020 Arese, (Milano), Italy, Telephone: (39) 02-935-81-733, Fax: (39) 02-935-81-741

China: Hamamatsu Photonics (China) Co., Ltd.: 1201 Tower B, Jiaming Center, No.27 Dongsanhuan Beilu, Chaoyang District, Beijing 100020, China, Telephone: (86) 10-6586-6006, Fax: (86) 10-6586-2866