

S11012-01CR

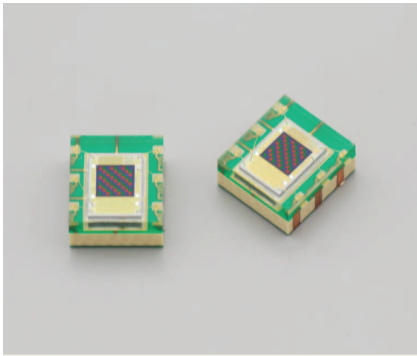

## 12-bit digital output

The S11012-01CR is a digital color sensor sensitive to red ( $\lambda=615$  nm), green ( $\lambda=540$  nm) and blue ( $\lambda=465$  nm) regions of the spectrum. Detected signals are serially output as 12-bit digital data. Built-in three 12-bit registers allow simultaneous measurement of RGB three colors. Sensitivity level is adjustable in two steps to cover a wide photometric range.

### Features

- 12-bit digital output
- COB type
- Simultaneous measurement of RGB three colors
- 2-step sensitivity switching (sensitivity ratio of 1 : 9)
- Low voltage (3.3 V) operation
- CMOS monolithic photo IC
- No external components required

### Applications

- Display color adjustment
- Various applications involving color detection

### Feature 01 12-bit digital output

Light signals detected by the photodiode are amplified and converted into 12-bit digital signals. An amplifier is also formed for each of the RGB photodiode elements arrayed in the mosaic pattern, allowing simultaneous accurate measurement of the RGB components of incident light.

### Feature 02 Simultaneous measurement of RGB three colors

The photodiode consists of  $9 \times 9$  elements arrayed in a mosaic pattern. Each element has an on-chip filter that is sensitive to one color of light, either red ( $\lambda_p=615$  nm), green ( $\lambda_p=540$  nm) or blue ( $\lambda_p=465$  nm).

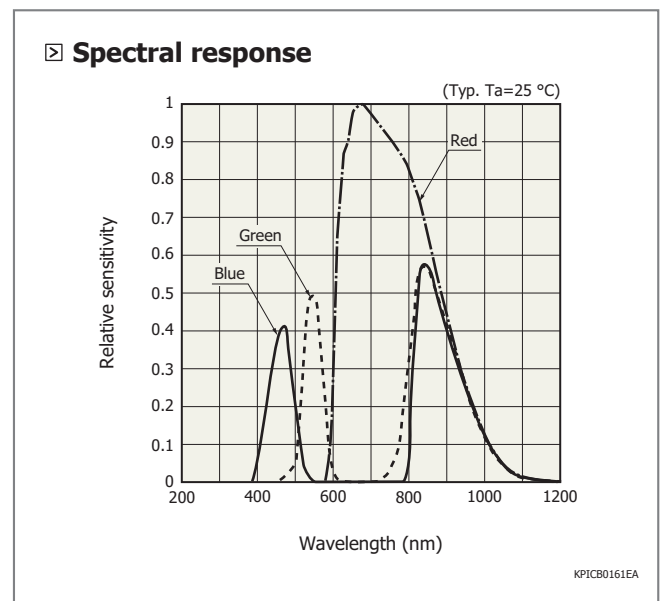
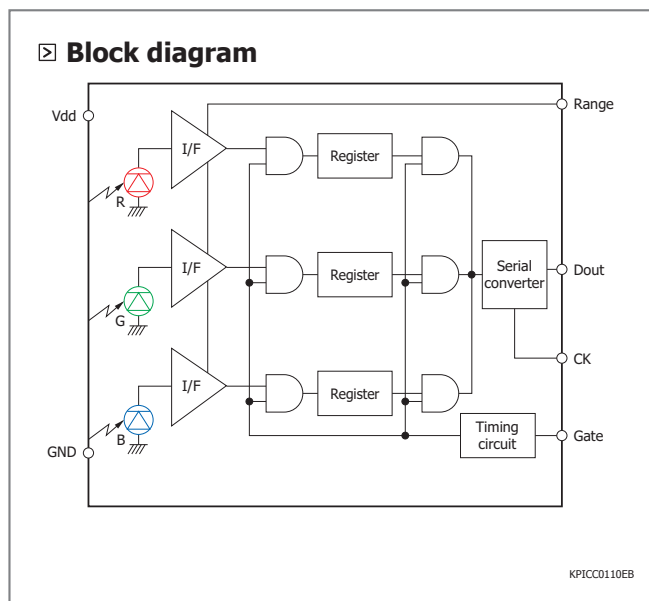

## Feature 03 2-step sensitivity switching

To enable measurement over a wide range of illuminance, the photodiode sensitivity can be selected from two setting modes (high sensitivity mode and low sensitivity mode). The photodiode photosensitive area used to detect light differs depending on which sensitivity mode is selected (high sensitivity mode:  $9 \times 9$  elements, low sensitivity mode:  $3 \times 3$  elements in center).

### ☒ Sensitivity setting

Range	Mode	Effective photosensitive area*
High	High sensitivity	$9 \times 9$ elements
Low	Low sensitivity	$3 \times 3$ elements

\* The photosensitive area of the S11012-01CR consists of  $9 \times 9$  elements in a mosaic pattern.

The effective photosensitive area changes depending on which sensitivity mode is used, "high" or "low", as explained below.

- High sensitivity mode:  $9 \times 9$  elements
- Low sensitivity mode:  $3 \times 3$  elements in center

### ☒ Details of photosensitive area (unit: $\mu\text{m}$ )

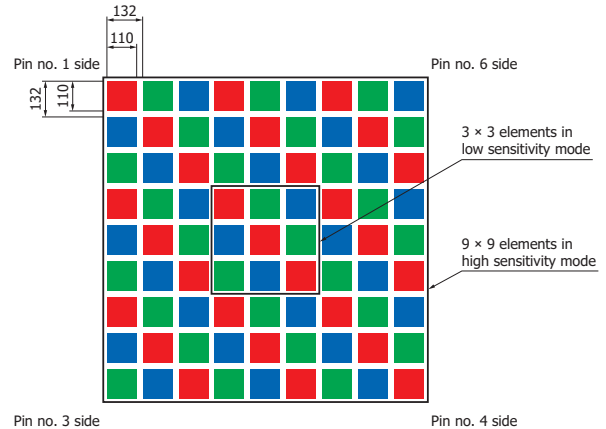

Note: Spacing between elements is light-shielded.

KPIC0124EB

### ☒ Absolute maximum ratings

Parameter	Symbol	Condition	Value	Unit
Supply voltage	Vdd	$T_a = 25 \text{ }^\circ\text{C}$	-0.3 to 6	V
Load current	I <sub>o</sub>	$T_a = 25 \text{ }^\circ\text{C}$	$\pm 10$	mA
Power dissipation	P	$T_a = 25 \text{ }^\circ\text{C}$	100	mW
Operating temperature	T <sub>opr</sub>		-20 to +80	$^\circ\text{C}$
Storage temperature	T <sub>stg</sub>		-20 to +85	$^\circ\text{C}$
Reflow soldering conditions	T <sub>sol</sub>		Peak temperature $240 \text{ }^\circ\text{C}$ max., one time	-

Note: Exceeding the absolute maximum ratings even momentarily may cause a drop in product quality. Always be sure to use the product within the absolute maximum ratings.

\*1: JEDEC level 5a

### Electrical and optical characteristics (Ta=25 °C, Vdd=5 V, Tg=100 ms, A light source, unless otherwise noted)

Parameter	Symbol	Condition	Min.	Typ.	Max.	Unit
Photosensitive area size	-	All elements (9 × 9 elements)	-	1.2 × 1.2	-	mm
Effective photosensitive area	-	All elements (9 × 9 elements) per 1 color, high range	-	0.32	-	mm <sup>2</sup>
		3 × 3 elements per 1 color, low range	-	0.036	-	
Spectral response range*2	λ	Blue	-	400 to 540 800 to 1000	-	nm
		Green	-	480 to 600 760 to 1000	-	
		Red	-	590 to 1000	-	
Supply voltage	Vdd		3.0	-	5.5	V
Current consumption	Idd	Dark state, no load	-	5	10	mA
Photo sensitivity	Sbl	Blue, low range	0.21	0.3	0.39	LSB/lx
	Sgl	Green, low range	0.42	0.6	0.78	
	Srl	Red, low range	0.98	1.4	1.82	
	Sbh	Blue, high range	1.8	2.6	3.4	
	Sgh	Green, high range	3.7	5.3	6.9	
	Srh	Red, high range	9.0	12.9	16.8	
Incident light power (Conversion value in A light source)	Ibl	Blue, low range	-	-	172	k/lx
	Igl	Green, low range	-	-	83	
	Irl	Red, low range	-	-	35	
	Ibh	Blue, high range	-	-	19	
	Igh	Green, high range	-	-	9.2	
	Irh	Red, high range	-	-	3.9	
Dark output	Dark	Tg=0.5 s, high range	-	-	1	LSB
Input high level	Vih		Vdd × 0.82	-	-	V
Input low level	Vil		-	-	Vdd × 0.18	V
High level output voltage	Voh	Ioh=-0.5 mA	4.5	-	-	V
Low level output voltage	Vol	Iol=0.5 mA	-	-	0.5	V
Integration time	Tg		Refer to "Output vs. illuminance"			-
Hold time	t1		4	-	-	μs
	t2		3	-	-	μs
	t3		3	-	-	μs
	t4		2000	-	-	μs
	t5		3	-	-	μs
Readout clock period	tck		500	-	-	ns
Readout pulse width (positive)	tw		200	-	-	ns

\*2: Since this product has sensitivity in the infrared region, infrared light must be filtered out as needed.

**Output vs. illuminance**

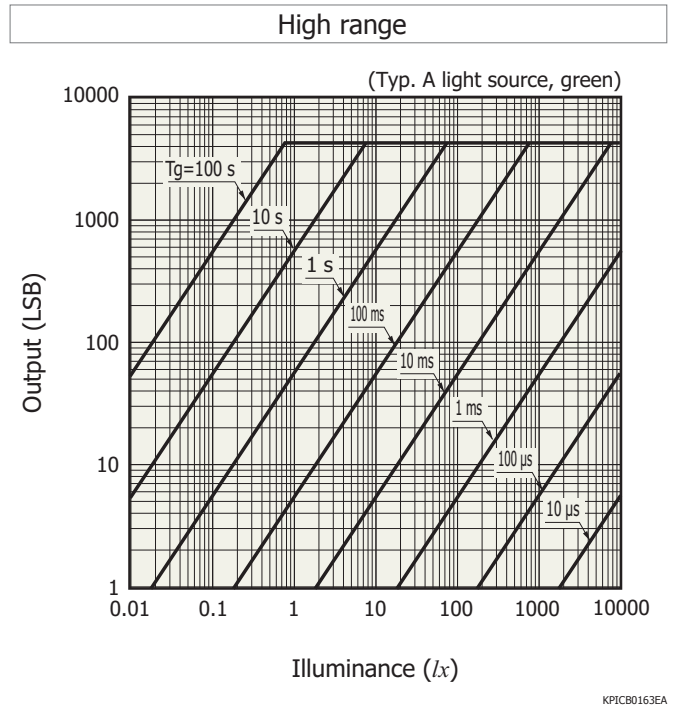
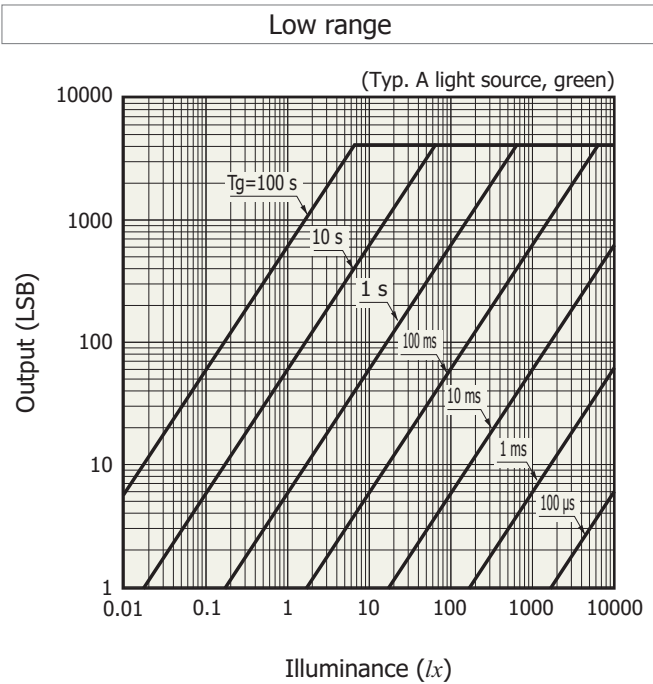

**Timing chart**

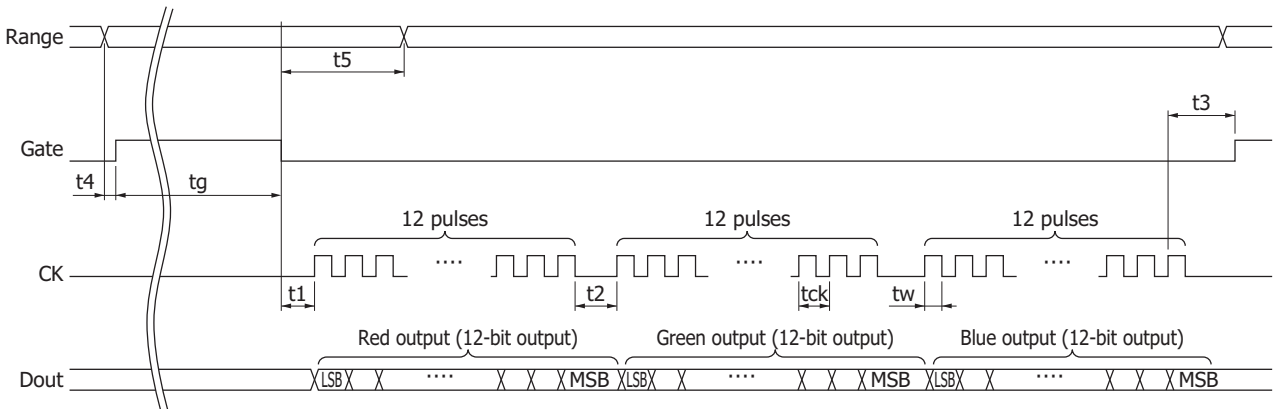

- (1) Set the Gate terminal and CK terminal to "Low".
- (2) Select the desired sensitivity with the Range terminal.
- (3) Set the Gate terminal from "Low" to "High", to start integrating the light intensity.
- (4) After the desired integration time ( $t_g$ ) has passed, set the Gate terminal from "High" to "Low" to end the light intensity integration.
- (5) Measurement data is output from the Dout terminal by inputting 36 CK pulses to the CK terminal.

Note 1: A total of 36 CK pulses are required to read out 3-color measurement data. Red data is output by the first 12 pulses, green data by the next 12 pulses, and blue data by the last 12 pulses. Measurement data is output from the LSB side.

Note 2: Measurement data changes at the CK pulse rising edge.

Note 3: Do not switch the Range terminal during integration time ( $t_g$ ).

KPIC00115EB

**Dimensional outline (unit: mm)**

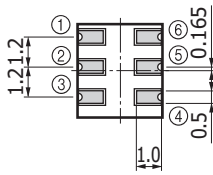
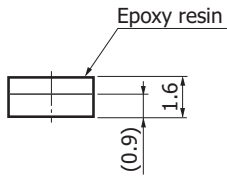
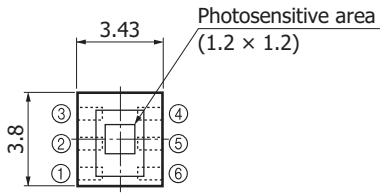

- ① GND
- ② Vdd
- ③ Dout
- ④ Gate
- ⑤ CK
- ⑥ Range

Tolerance unless otherwise noted:  $\pm 0.2$   
 Chip position accuracy with respect to package center  
 $X, Y \leq \pm 0.3$   
 Values in parentheses indicate reference value.  
 ■ Electrode

KPICA0088EA

**Recommended land pattern (unit: mm)**

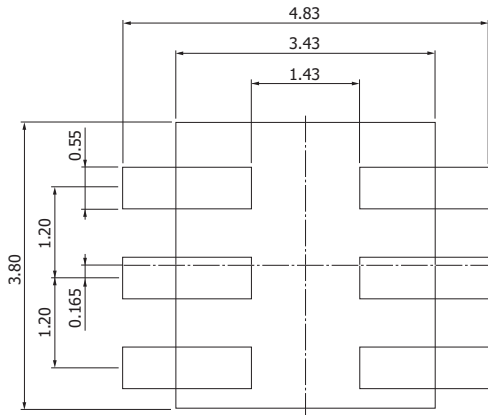



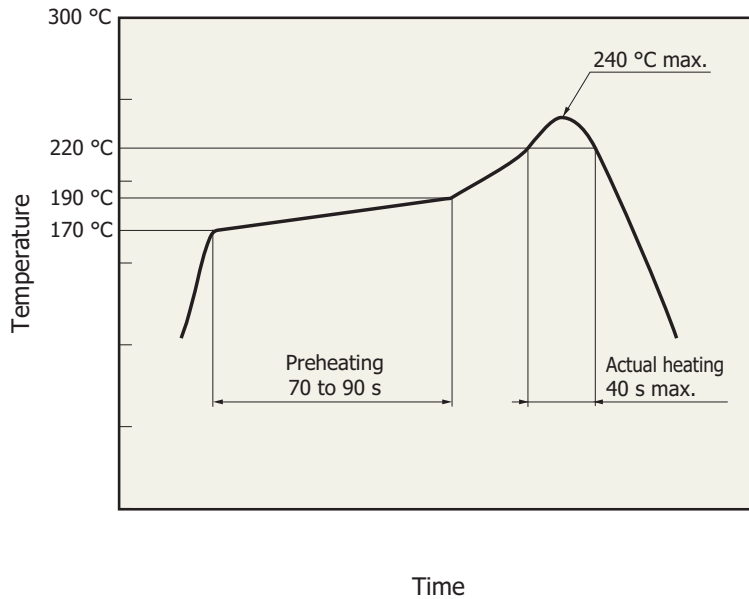









KPIC0199EA

**Measured example of temperature profile with hot-air reflow oven for product testing**

KPICB0164EC

- This product supports lead-free soldering. After unpacking, store it in an environment at a temperature of 30 °C or less and a humidity of 60% or less, and perform soldering within 24 hours.
- The effect that the product receives during reflow soldering varies depending on the circuit board and reflow oven that are used. Before actual reflow soldering, check for any problems by testing out the reflow soldering methods in advance.

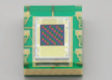
### Line-up of RGB color sensors

Type no.	Type	Photosensitive area (mm)	Package (mm)	Peak sensitivity wavelength (nm)		Photosensitivity				Photo				
				B	G	B	G	R	High		B	G	R	IR
S9032-02	Photodiode	 $\phi 2.0$	4 × 4.8 × 1.8 <sup>t</sup> 6 pin (filter 0.75 <sup>t</sup> )	B	460	B	0.18 (A/W) [ $\lambda=460$ nm]							
				G	540	G	0.23 (A/W) [ $\lambda=540$ nm]							
				R	620	R	0.16 (A/W) [ $\lambda=620$ nm]							
S9702	Photodiode	 1.0 × 1.0	3 × 4 × 1.3 <sup>t</sup> 4 pin (filter 0.75 <sup>t</sup> )	B	460	B	0.18 (A/W) [ $\lambda=460$ nm]							
				G	540	G	0.23 (A/W) [ $\lambda=540$ nm]							
				R	620	R	0.16 (A/W) [ $\lambda=620$ nm]							
S10917-35GT	Photodiode	 1.0 × 1.0	3 × 1.6 × 1.0 <sup>t</sup> COB (on-chip filter)	B	460	B	0.2 (A/W) [ $\lambda=460$ nm]							
				G	540	G	0.23 (A/W) [ $\lambda=540$ nm]							
				R	620	R	0.17 (A/W) [ $\lambda=620$ nm]							
S10942-01CT	Photodiode	 1.0 × 1.0	3 × 1.6 × 1.0 <sup>t</sup> COB (on-chip filter)	*		B	0.21 (A/W) [ $\lambda=460$ nm]							
						G	0.25 (A/W) [ $\lambda=540$ nm]							
						R	0.45 (A/W) [ $\lambda=640$ nm]							
S9706	Digital photo IC	 1.2 × 1.2	4 × 4.8 × 1.8 <sup>t</sup> 6 pin (filter 0.75 <sup>t</sup> )	B	465	Low	B	0.21 (LSB/lx)		High	B	1.9 (LSB/lx)		
				G	540		G	0.45 (LSB/lx)			G	4.1 (LSB/lx)		
				R	615		R	0.64 (LSB/lx)			R	5.8 (LSB/lx)		
S11012-01CR	Digital photo IC	 1.2 × 1.2	3.43 × 3.8 × 1.6 <sup>t</sup> COB (on-chip filter)	*		Low	B	0.3 (LSB/lx)		High	B	2.6 (LSB/lx)		
							G	0.6 (LSB/lx)			G	5.3 (LSB/lx)		
							R	1.4 (LSB/lx)			R	12.9 (LSB/lx)		
S11059-02DT /-03DS	I <sup>2</sup> C compatible color sensor	 0.56 × 1.22	3 × 4.2 × 1.3 <sup>t</sup> 10 pin (on-chip filter)	B	460	Low	B	4.4 (count/lx)		High	B	44.8 (count/lx)		
				G	530		G	8.3 (count/lx)			G	85.0 (count/lx)		
				R	615		R	11.2 (count/lx)			R	117.0 (count/lx)		
				IR	855		IR	3.0 (count/lx)			IR	30.0 (count/lx)		

\* Refer to the spectral response of each product's datasheet.

### Related information

[www.hamamatsu.com/sp/ssd/doc\\_en.html](http://www.hamamatsu.com/sp/ssd/doc_en.html)

#### Precautions

- Disclaimer
- Metal, ceramic, plastic package products
- Surface mount type products

Information described in this material is current as of February, 2016.

Product specifications are subject to change without prior notice due to improvements or other reasons. This document has been carefully prepared and the information contained is believed to be accurate. In rare cases, however, there may be inaccuracies such as text errors. Before using these products, always contact us for the delivery specification sheet to check the latest specifications.

The product warranty is valid for one year after delivery and is limited to product repair or replacement for defects discovered and reported to us within that one year period. However, even if within the warranty period we accept absolutely no liability for any loss caused by natural disasters or improper product use. Copying or reprinting the contents described in this material in whole or in part is prohibited without our prior permission.

# HAMAMATSU

[www.hamamatsu.com](http://www.hamamatsu.com)

HAMAMATSU PHOTONICS K.K., Solid State Division

1126-1 Ichino-cho, Higashi-ku, Hamamatsu City, 435-8558 Japan, Telephone: (81) 53-434-3311, Fax: (81) 53-434-5184

U.S.A.: Hamamatsu Corporation, 360 Foothill Road, Bridgewater, N.J. 08807, U.S.A., Telephone: (1) 908-231-0960, Fax: (1) 908-231-1218

Germany: Hamamatsu Photonics Deutschland GmbH: Arzbergerstr. 10, D-82211 Herrsching am Ammersee, Germany, Telephone: (49) 8152-375-0, Fax: (49) 8152-265-8

France: Hamamatsu Photonics France S.A.R.L.: 19, Rue du Saule Trapu, Parc du Moulin de Massy, 91882 Massy Cedex, France, Telephone: 33-(1) 69 53 71 00, Fax: 33-(1) 69 53 71 10

United Kingdom: Hamamatsu Photonics UK Limited: 2 Howard Court, 10 Tewin Road, Welwyn Garden City, Hertfordshire AL7 1BW, United Kingdom, Telephone: (44) 1707-294888, Fax: (44) 1707-325777

North Europe: Hamamatsu Photonics Norden AB: Torshamnsgatan 35 16440 Kista, Sweden, Telephone: (46) 8-509-031-00, Fax: (46) 8-509-031-01

Italy: Hamamatsu Photonics Italia S.r.l.: Strada della Moia, 1 int. 6, 20020 Arese (Milano), Italy, Telephone: (39) 02-93581733, Fax: (39) 02-93581741

China: Hamamatsu Photonics (China) Co., Ltd.: B1201, Jiaming Center, No.27 Dongsanhuan Beilu, Chaoyang District, Beijing 100020, China, Telephone: (86) 10-6586-6006, Fax: (86) 10-6586-2866