



C13272-02

Ultra-compact near infrared spectrum sensor that integrates MEMS tunable filter and photo-sensor

The MEMS-FPI spectrum sensor S13272-02 is a ultra-compact sensor that houses a MEMS-FPI (Fabry-Perot Interferometer) tunable filter that can vary its transmission wavelength depending on the applied voltage and InGaAs PIN photodiode in a single package. The spectral response range is 1550 to 1850 nm. It is suitable for installation in simple, compact instruments for measuring material absorbance and the like.

Features

- Built-in Hamamatsu InGaAs PIN photodiode single element chip
- Spectral response range: 1550 to 1850 nm
- Ultra-compact: TO-5 package
- Ultra light: 1 g
- Hermetically sealed package: High reliability in high humidity environment
- Built-in thermistor
- Built-in band-pass filter for cutting off wavelengths outside the spectral response range

Applications

- Screening of plastic, solutions, and the like
- Gas detection
- Installation into mobile measuring devices
- Use in combination with portable devices such as smartphones and tablets.

Absolute maximum ratings (Ta=25 °C unless otherwise noted)

Parameter	Symbol	Condition	Value	Unit
Filter control voltage*1	-		$V_{\lambda 1550\text{nm}} + 0.5$	V
Photosensor reverse voltage	V_R		1	V
Photosensor forward current	I_F		10	mA
Operating temperature*2	T_{opr}		-40 to +85	°C
Storage temperature*2	T_{stg}		-40 to +125	°C
Recommended soldering conditions	-		260 °C or less, within 10 s	-
Electrostatic withstand voltage*3	-	Terminals other than photosensor terminals	500	V(HBM)*4
		Between the anode and cathode of the photosensor	100	

*1: Applying a voltage that is +0.5 V or higher than $V_{\lambda 1550\text{nm}}$ (filter control voltage to transmit light at $\lambda=1550$ nm) at a specific temperature may damage the MEMS-FPI tunable filter. For $V_{\lambda 1550\text{nm}}$ of individual products at $T_a=25^\circ\text{C}$, see the final inspection sheet.

*2: No condensation

When there is a temperature difference between a product and the surrounding area in high humidity environment, dew condensation may occur on the product surface. Dew condensation on the product may cause deterioration in characteristics and reliability.

*3: This product is an electrostatic sensitive device. When handling the product, precautions need to be taken to avoid damage and deterioration due to static electricity. For details, refer to the instruction manual supplied with the product.

*4: Human body model

Note: Exceeding the absolute maximum ratings even momentarily may cause a drop in product quality. Always be sure to use the product within the absolute maximum ratings.

Electrical and optical characteristics of MEMS-FPI spectrum sensor (Ta=25 °C, unless otherwise noted)

Parameter	Symbol	Min.	Typ.	Max.	Unit
Spectral response range	λ		1550 to 1850		nm
Spectral resolution (FWHM)*5	-	-	-	20	nm
Wavelength temperature dependence*6	-	-	0.4	-	nm/°C
Wavelength reproducibility*7	-	-	± 2	-	nm
Settling time (0 V \rightarrow V λ 1550nm)*8	-	-	1	-	ms
Dark current*9	I _D	-	4	40	nA
Thermistor resistance	-	9.6	-	10.4	k Ω

*5: Incident angle=0°, photosensor NA=0.09

*6: λ =1700 nm

*7: When filter control voltage, incident light condition, and usage environment, etc. are constant

*8: Time for the output signal to reach 99% of the stable signal level when the control voltage of the MEMS-FPI tunable filter is varied from 0 V to V λ 1550nm

*9: V_R=0.5 V

Electrical and optical characteristics of built-in InGaAs PIN photodiode (Ta=25 °C unless otherwise noted)

Parameter	Symbol	Condition	Min.	Typ.	Max.	Unit
Photosensitive area	A			$\phi 0.1$		mm
Spectral response range	λ			900 to 2100		nm
Peak sensitivity wavelength	λ_p		1800	1950	2050	nm
Photosensitivity	S	$\lambda = \lambda_p$	1.0	1.2	-	A/W
Detectivity	D*	$\lambda = \lambda_p$	9×10^{10}	2.5×10^{11}	-	cm \cdot Hz ^{1/2} /W
Noise equivalent power	NEP	$\lambda = \lambda_p$	-	4×10^{-14}	9×10^{-14}	W/Hz ^{1/2}
Terminal capacitance	C _t	V _R =0 V, f=1 MHz	-	8	20	pF

Temperature characteristics of V λ 1550nm (typical example)

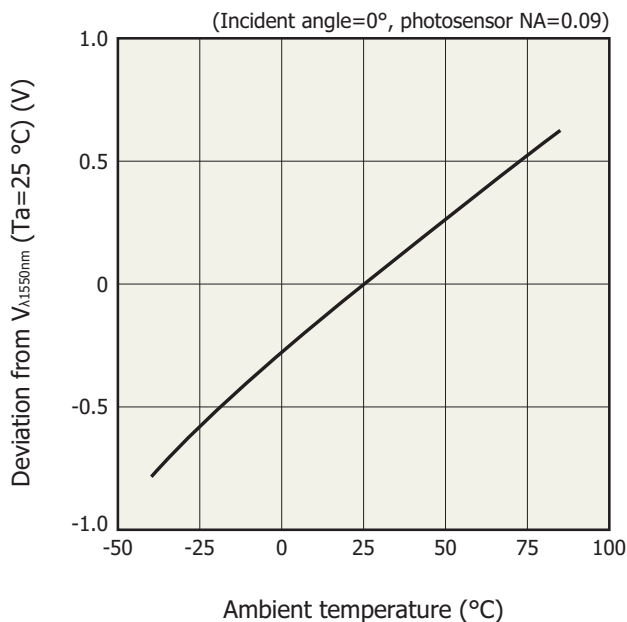

KACCB0400EC

Peak transmission wavelength vs. filter control voltage (typical example)

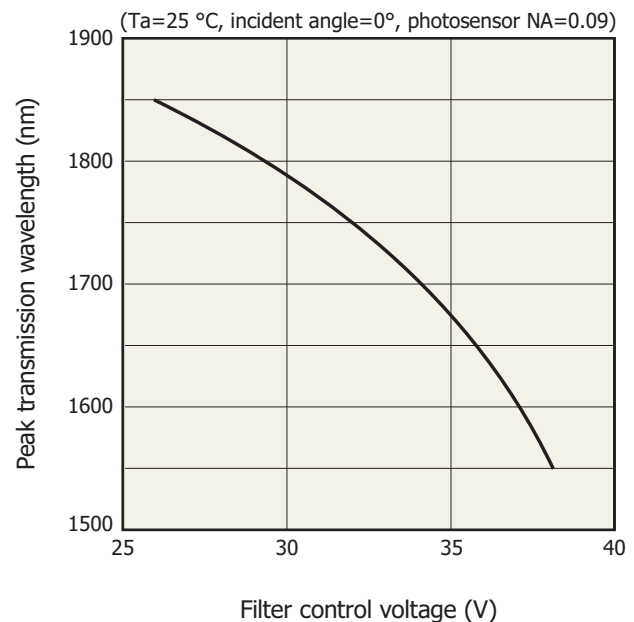

KACCB0401EC

▣ Spectral resolution vs. peak transmission wavelength (typical example)

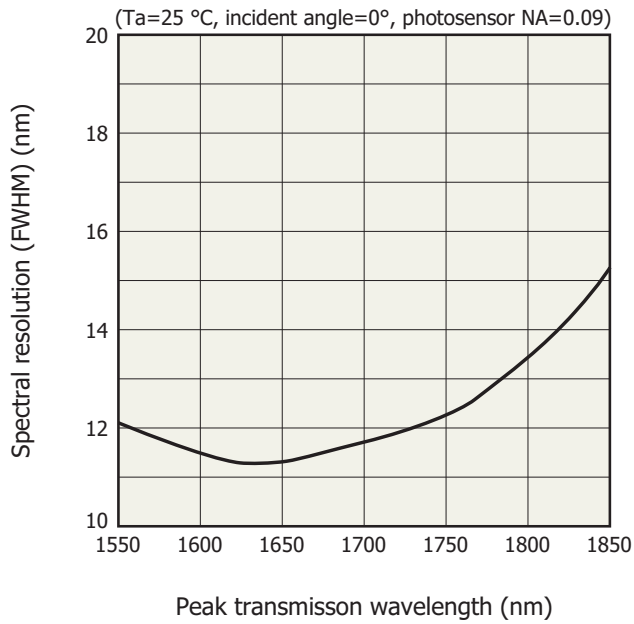

▣ Peak transmission wavelength vs. ambient temperature (typical example)

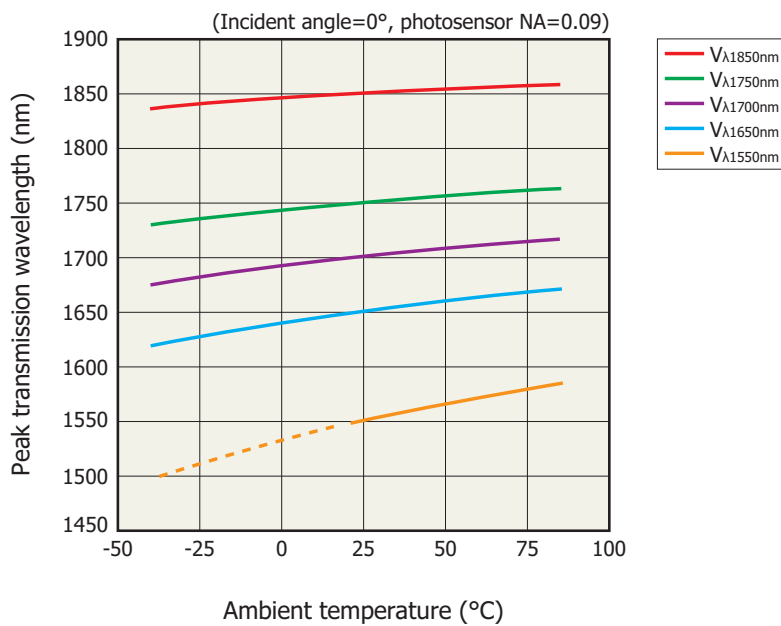

The broken line corresponds to data when the built-in band-pass filter is removed. The C13272-02 cannot detect the peak transmission wavelength accurately in this range. This is because when the ambient temperature is less than $25\text{ }^\circ\text{C}$, the peak transmission wavelength of the MEMS-FPI tunable filter is outside the transmission wavelength range of the band-pass filter.

Filter control voltage vs. ambient temperature (typical example)

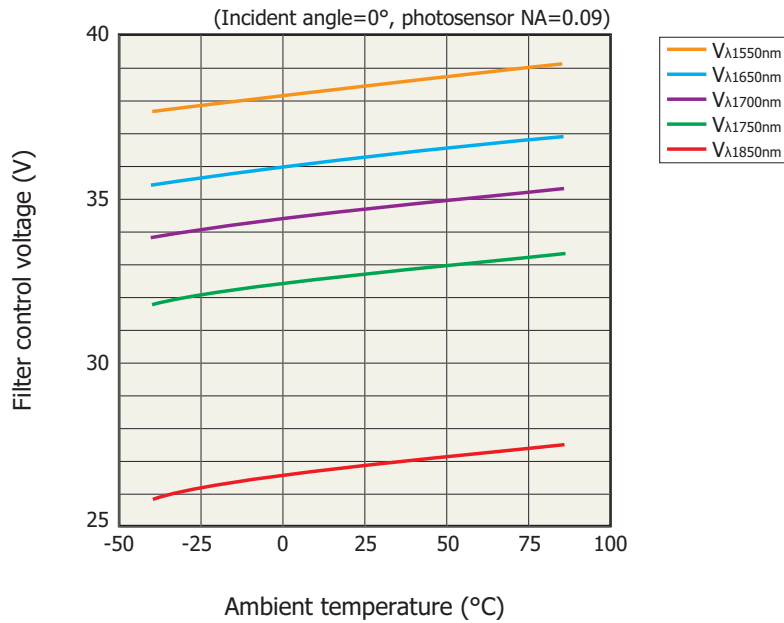

KACCB0432EB

Spectral transmittance characteristics of band-pass filter (typical example)

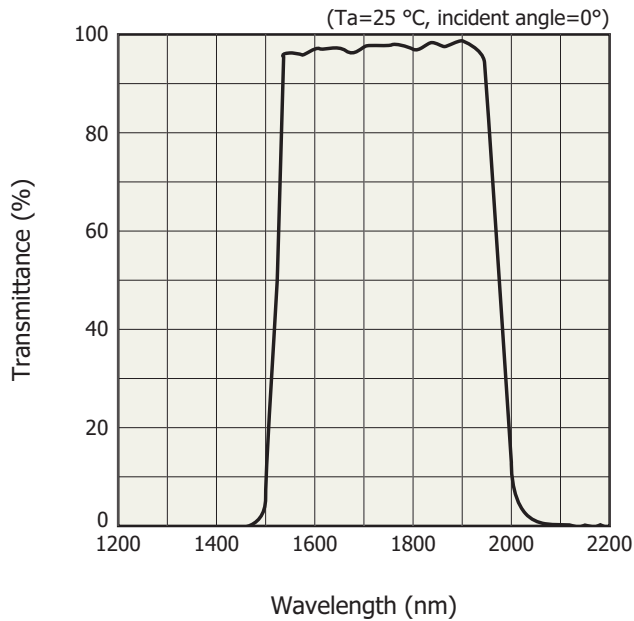

KACCB0433EB

Thermistor resistance vs. temperature (typical example)

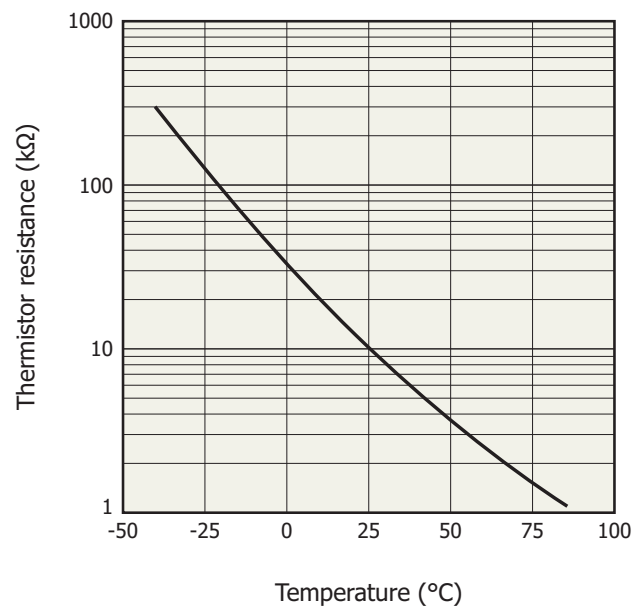

KACCB0404EB

Transmittance of MEMS-FPI tunable filter vs. wavelength (typical example)

[Ta=25 °C, input line spectrum, line spectrum resolution (FWHM)= 3 nm max.,
incident angle=0°, photosensor NA=0.09]

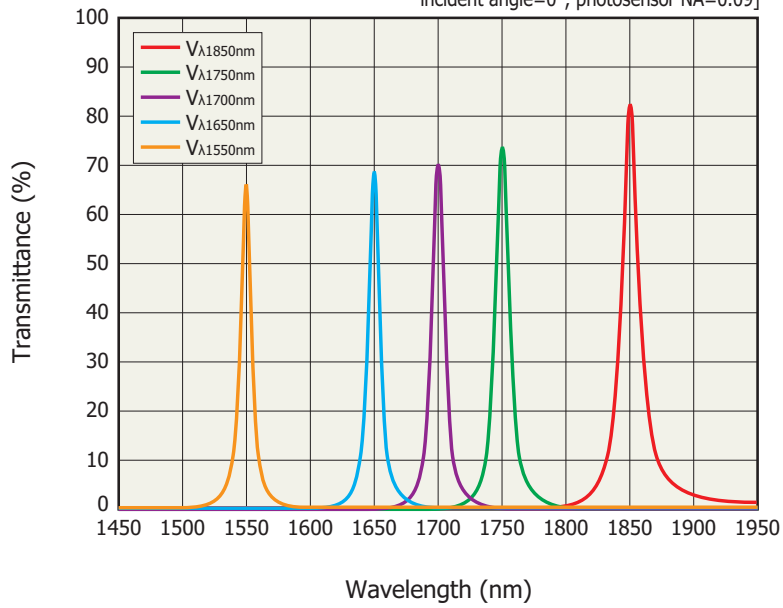

- There is tolerance in filter control voltage for arbitrary peak transmission wavelength from unit to unit. The individual data for V_{λ1850nm} and V_{λ1550nm} at Ta=25 °C is to be described in an inspection sheet attached with a product on delivery.

KACCB0405EA

Dimensional outline (unit: mm)

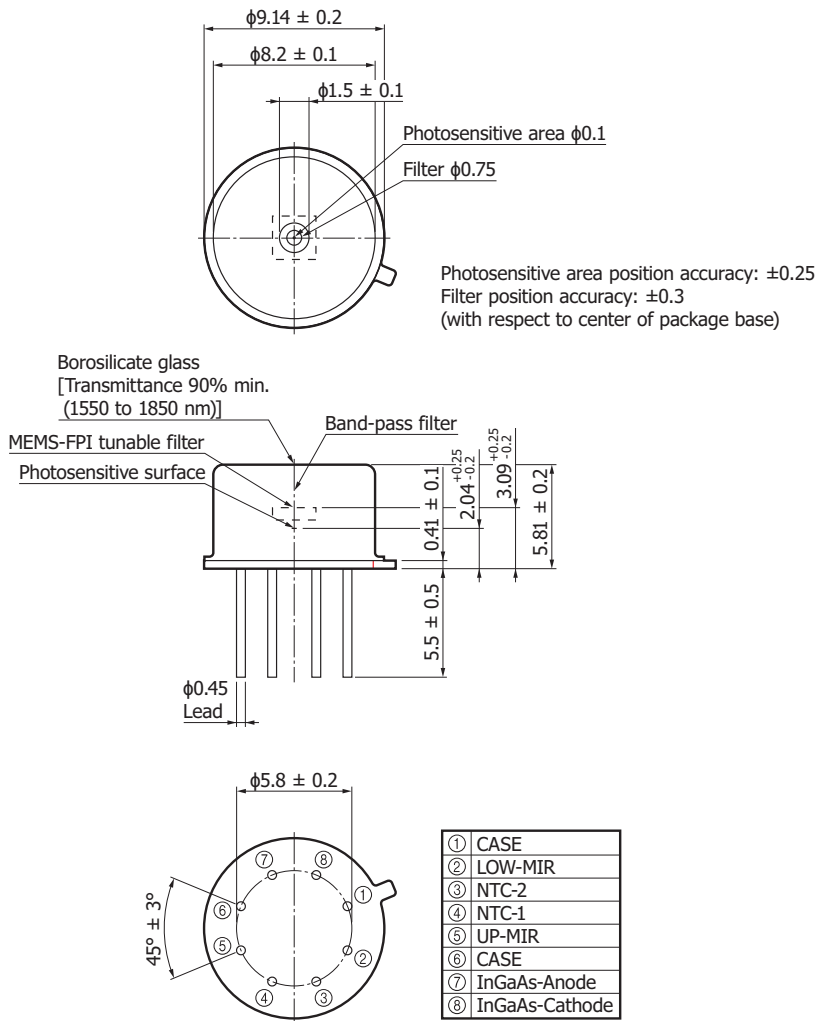

KACCA0385EC

Pin connections

Pin no.	Name	Input/Output	Description
1	CASE	-	Case connection
2	LOW-MIR	Input	MEMS-FPI tunable filter lower electrode
3	NTC-2	Output	For thermistor
4	NTC-1	Output	For thermistor
5	UP-MIR	Input	MEMS-FPI tunable filter upper electrode
6	CASE	-	Case connection
7	InGaAs-Anode	Output	
8	InGaAs-Cathode	Output	

Marking information

Marking item	Description
DataMatrix	Shape: rectangle Cell size: 0.14 × 0.14 mm Symbol size: 12 × 26 cell Input information example: C13272-02, ***** ("Type no." + "," + "Serial no.")
C13272-02	Type no.
*****	Serial no. ** : information on year and month ##### : number of five digits (number of individual product)

Marking example on cap

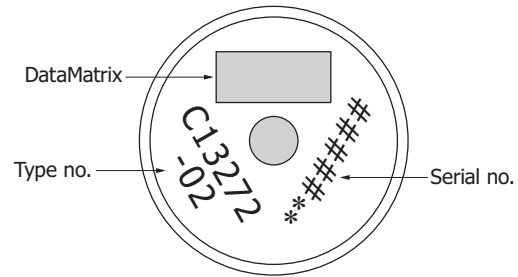

KACCC0837EB

Note: KEYENCE CORPORATION code reader SR-1000 is recommended for reading the DataMatrix.

Connection example

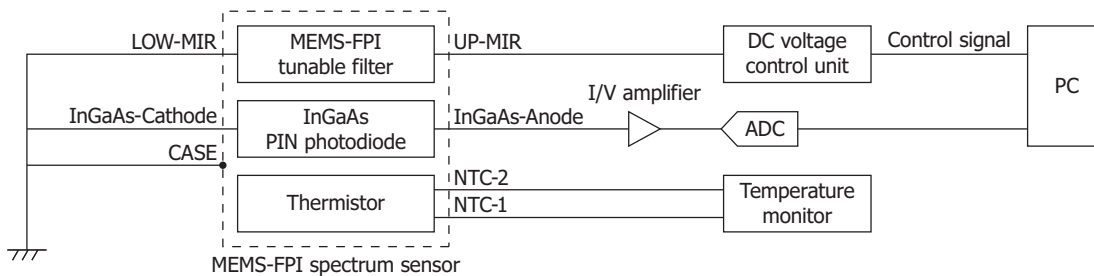

KACCC0804EA

MEMS-FPI spectrum sensor structure

The MEMS-FPI spectrum sensor is composed of a MEMS-FPI tunable filter, photosensor (photodiode), and the like. It has a simple structure in which a MEMS-FPI tunable filter and photosensor is arranged on the same axis as the direction of the incident light. Though this product is a spectrum sensor, it uses a single-element photosensor and does not require an expensive multichannel photosensor.

Internal structure

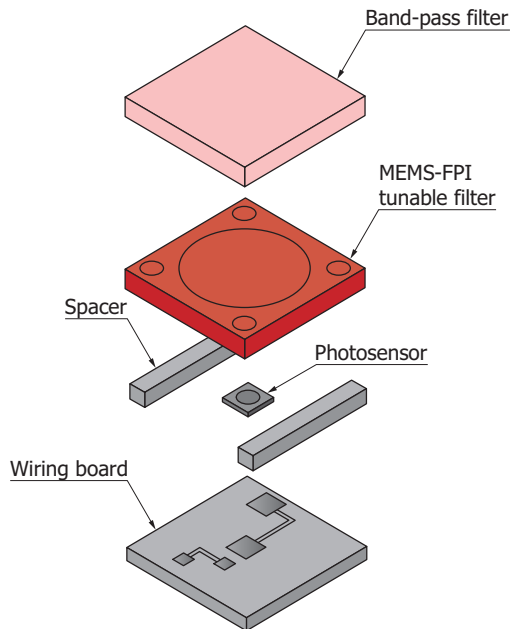

KIRDC0108EC

MEMS-FPI tunable filter

The MEMS-FPI tunable filter has an upper mirror and a lower mirror that are placed opposite each other with an air gap in between them. When a voltage is applied across the mirrors, an electrostatic attractive force is produced to adjust the air gap. To facilitate this action, the upper mirror has a membrane (thin film) structure. If the air gap is $m\lambda/2$ (m : integer), it functions as a filter that allows wavelengths near λ to pass through. When the filter control voltage is increased, the air gap is narrowed by the electrostatic attractive force, and the transmission peak wavelength shifts to the short-wavelength side.

MEMS-FPI tunable filter cross section

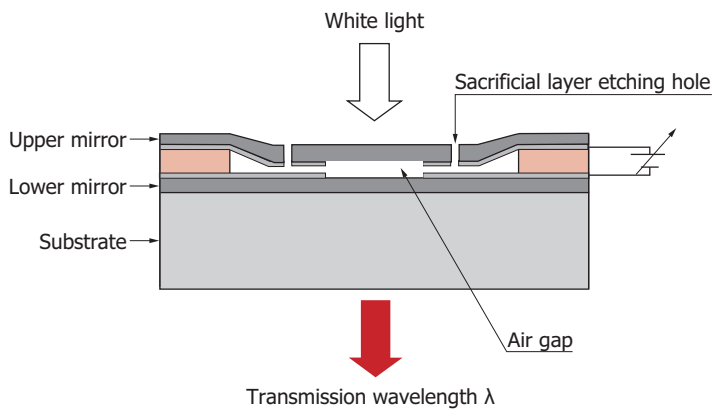

KIRDC0109EA

Spectral response (typical example)

[$T_a=25\text{ }^\circ\text{C}$, input line spectrum, line spectrum resolution (FWHM)= 3 nm max., incident angle= 0° , photosensor NA=0.09]

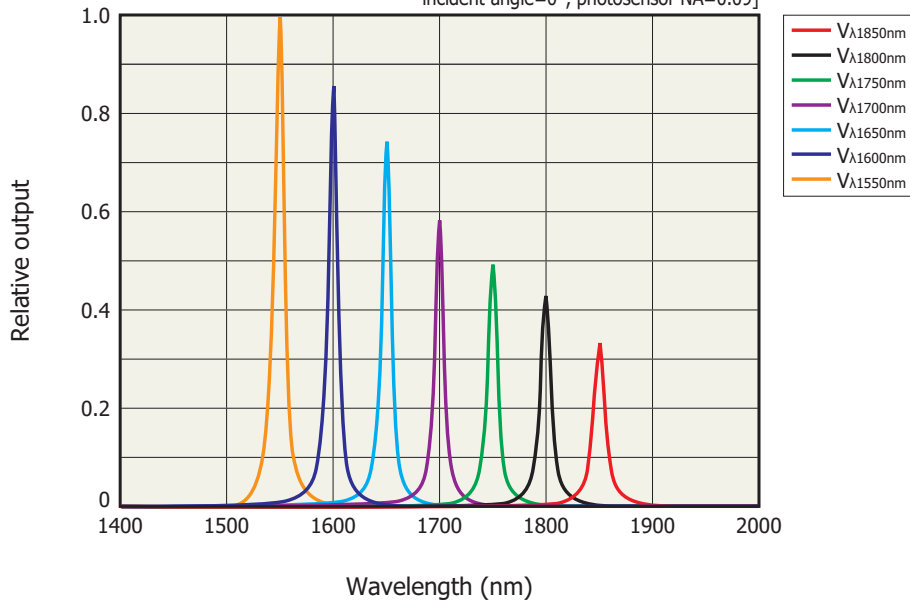

KACC80434ED

Evaluation circuit for MEMS-FPI spectrum sensor C13294-02 (sold separately)

The C13294-02 is a circuit board designed to simply evaluate the C13272-02 and C14272 MEMS-FPI spectrum sensors. By connecting the circuit board to a PC (sold separately) with a USB cable (A-micro B type) and using the accompanying evaluation software*10, you can evaluate the characteristics of the C13272-02 and C14272.

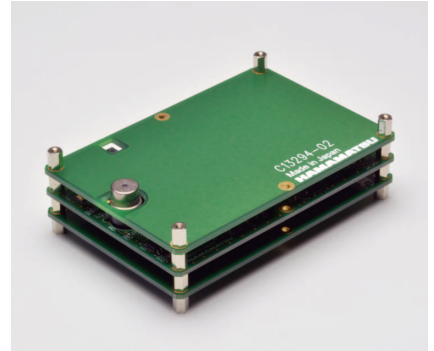

*10: Compatible OS

Microsoft® Windows® 7 Professional SP1 (32-bit/64-bit)

Microsoft Windows 8.1 Pro (32-bit, 64-bit)

Microsoft Windows 10 Pro (32-bit, 64-bit)

Microsoft and Windows are registered trademarks of Microsoft Corporation in the United States and/or other countries.

Electrical characteristics

Parameter	Specification	Unit
Interface	USB 2.0*11	-
A/D conversion	16	bit
Gain*12	L: 4.33×10^6 H: 4.32×10^7	-

*11: Power to this product is supplied from the USB port on the PC and this product consumes a maximum current of 500 mA. Use the USB port which can supply current of 500 mA. Due to the USB specifications, the maximum power that can be supplied from one USB port is limited to 5 V, 500 mA. Avoid connecting two or more units to one USB port through a hub.

*12: Design value

Structure

Parameter	Specification	Unit
Compatible spectrum sensor	C13272-02, C14272	-
Dimensions	90 × 60 × 28.8	mm

Absolute maximum ratings

Parameter	Symbol	Value	Unit
Operating temperature*13	Topr	+5 to +40	°C
Storage temperature*13	Tstg	-20 to +70	°C

*13: No dew condensation

When there is a temperature difference between a product and the surrounding area in high humidity environment, dew condensation may occur on the product surface. Dew condensation on the product may cause deterioration in characteristics and reliability.

Note: Exceeding the absolute maximum ratings even momentarily may cause a drop in product quality. Always be sure to use the product within the absolute maximum ratings.

Precautions

Note the following when handling the product and also after installing into a device.

■ Handling

- When touching the product, it is recommended to wear gloves or use tweezers. Touching the product with bare hands may cause degradation in characteristics and plating corrosion and may lead to problems with solder wettability.
- Perform work in a clean place.

■ Filter control voltage

- Apply filter control voltage as defined by the absolute maximum ratings. Applying a filter control voltage exceeding the absolute maximum ratings may damage the MEMS-FPI tunable filter.

■ Static electricity

- The MEMS-FPI spectrum sensor is an electrostatic sensitive device. When handling the product, precautions need to be taken to avoid damage and deterioration due to static electricity. For details, refer to the instruction manual supplied with the product.

Selection guide

Type no.	Spectral response range	Spectral resolution (FWHM)
	Typ. (nm)	Max. (nm)
C13272-02	1550 to 1850	20
C14272	1350 to 1650	18

Related information

www.hamamatsu.com/sp/ssd/doc_en.html

■ Precautions

- Disclaimer
- Safety consideration

■ Technical information

- MEMS-FPI spectrum sensors
- Infrared detectors

Information described in this material is current as of October 2017.

Product specifications are subject to change without prior notice due to improvements or other reasons. This document has been carefully prepared and the information contained is believed to be accurate. In rare cases, however, there may be inaccuracies such as text errors. Before using these products, always contact us for the delivery specification sheet to check the latest specifications.

The product warranty is valid for one year after delivery and is limited to product repair or replacement for defects discovered and reported to us within that one year period. However, even if within the warranty period we accept absolutely no liability for any loss caused by natural disasters or improper product use. Copying or reprinting the contents described in this material in whole or in part is prohibited without our prior permission.

HAMAMATSU

www.hamamatsu.com

HAMAMATSU PHOTONICS K.K., Solid State Division

1126-1 Ichino-cho, Higashi-ku, Hamamatsu City, 435-8558 Japan, Telephone: (81) 53-434-3311, Fax: (81) 53-434-5184

U.S.A.: Hamamatsu Corporation, 360 Foothill Road, Bridgewater, N.J. 08807, U.S.A., Telephone: (1) 908-231-0960, Fax: (1) 908-231-1218, E-mail: usa@hamamatsu.com

Germany: Hamamatsu Photonics Deutschland GmbH, Arzbergerstr. 10, D-82211 Herrsching am Ammersee, Germany, Telephone: (49) 8152-375-0, Fax: (49) 8152-265-8, E-mail: info@hamamatsu.de

France: Hamamatsu Photonics France S.A.R.L., 19, Rue du Saule Trapu, Parc du Moulin de Massy, 91882 Massy Cedex, France, Telephone: 33-(1) 69 53 71 00, Fax: 33-(1) 69 53 71 10, E-mail: infos@hamamatsu.fr

United Kingdom: Hamamatsu Photonics UK Limited, 2 Howard Court, 10 Tewin Road, Welwyn Garden City, Hertfordshire AL7 1BW, United Kingdom, Telephone: (44) 1707-294888, Fax: (44) 1707-325777, E-mail: info@hamamatsu.co.uk

North Europe: Hamamatsu Photonics Norden AB, Torshamnsgatan 35 16440 Kista, Sweden, Telephone: (46)8-509 031 00, Fax: (46)8-509 031 01, E-mail: info@hamamatsu.se

Italy: Hamamatsu Photonics Italia S.r.l., Strada della Moia, 1 int. 6, 20020 Arese (Milano), Italy, Telephone: (39)02-93 58 17 33, Fax: (39)02-93 58 17 41, E-mail: info@hamamatsu.it

China: Hamamatsu Photonics (China) Co., Ltd., B1201, Jiaming Center, No.27 Dongsanhuan Beilu, Chaoyang District, Beijing 100020, China, Telephone: (86) 10-6586-6006, Fax: (86) 10-6586-2866, E-mail: hpc@hamamatsu.com.cn

Taiwan: Hamamatsu Photonics Taiwan Co., Ltd., 8F-3, No. 158, Section2, Gongdao 5th Road, East District, Hsinchu, 300, Taiwan R.O.C. Telephone: (886)03-659-0080, Fax: (886)03-659-0081, E-mail: info@tw.hpk.co.jp